

INSTRUCTION BOOK

OIL-INJECTED ROTARY SCREW COMPRESSORS

G 2, G 3, G 4, G 5, G 7



Atlas Copco

Oil-injected rotary screw compressors

G 2, G 3, G 4, G 5, G 7

Instruction book

Original instructions

COPYRIGHT NOTICE

Any unauthorized use or copying of the contents or any part thereof is prohibited.

This applies in particular to trademarks, model denominations, part numbers and drawings.

This instruction book is valid for CE as well as non-CE labelled machines. It meets the requirements for instructions specified by the applicable European directives as identified in the Declaration of Conformity.

2020 - 12

No. 2920 7199 10

www.atlascopco.com



Table of contents

1	Safety precautions.....	5
1.1	SAFETY ICONS.....	5
1.2	GENERAL SAFETY PRECAUTIONS.....	5
1.3	SAFETY PRECAUTIONS DURING INSTALLATION.....	6
1.4	SAFETY PRECAUTIONS DURING OPERATION.....	7
1.5	SAFETY PRECAUTIONS DURING MAINTENANCE OR REPAIR.....	8
1.6	DISMANTLING AND DISPOSAL.....	10
2	General description.....	11
2.1	INTRODUCTION.....	11
2.2	AIR FLOW.....	13
2.3	OIL SYSTEM.....	16
2.4	COOLING SYSTEM.....	18
2.5	REGULATING SYSTEM.....	20
2.6	CONTROL PANEL	22
2.7	ELECTRICAL SYSTEM.....	23
2.8	PROTECTION OF THE COMPRESSOR.....	25
2.9	AIR DRYER.....	26
3	Controller.....	27
3.1	CONTROLLER.....	27
3.2	CONTROL PANEL.....	29
3.3	ICONS USED ON THE DISPLAY.....	30
3.4	MAIN SCREEN.....	31
3.5	MAIN FUNCTION.....	32
3.6	SHUTDOWN WARNING.....	34
3.7	SHUTDOWN.....	35
3.8	SERVICE WARNING.....	37



3.9	SCROLLING THROUGH ALL SCREENS.....	39
3.10	CALLING UP RUNNING HOURS.....	40
3.11	CALLING UP MOTOR STARTS.....	41
3.12	CALLING UP MODULE HOURS.....	41
3.13	CALLING UP LOADING HOURS.....	42
3.14	CALLING UP LOAD SOLENOID VALVE.....	42
3.15	CALLING UP/RESETTING THE SERVICE TIMER.....	43
3.16	CALLING UP/MODIFYING PRESSURE BAND SELECTION.....	43
3.17	CALLING UP/MODIFYING PRESSURE BAND SETTINGS.....	44
3.18	CALLING UP/MODIFYING THE UNIT OF TEMPERATURE.....	44
3.19	CALLING UP/MODIFYING THE UNIT OF PRESSURE.....	44
3.20	CALLING UP/MODIFYING BACKLIGHT TIME.....	45
3.21	ACTIVATING AUTOMATIC RESTART AFTER VOLTAGE FAILURE.....	45
3.22	KEYBOARD LOCK.....	46
4	Installation.....	47
4.1	INSTALLATION PROPOSAL.....	47
4.2	DIMENSION DRAWINGS.....	49
4.3	ELECTRICAL CONNECTIONS	50
4.4	PICTOGRAPHS.....	53
5	Operating instructions.....	55
5.1	INITIAL START-UP.....	55
5.2	STARTING.....	59
5.3	STOPPING.....	62
5.4	TAKING OUT OF OPERATION.....	64
6	Maintenance.....	66
6.1	PREVENTIVE MAINTENANCE SCHEDULE.....	66
6.2	DRIVE MOTOR	67

6.3	OIL SPECIFICATIONS.....	68
6.4	OIL, FILTER AND SEPARATOR CHANGE	69
6.5	STORAGE AFTER INSTALLATION.....	71
6.6	SERVICE KITS.....	71
7	Adjustments and servicing procedures.....	72
7.1	AIR FILTER.....	72
7.2	COOLERS.....	73
7.3	SAFETY VALVE	73
7.4	BELT SET EXCHANGE AND TENSIONING	75
8	Problem solving.....	77
9	Technical data.....	80
9.1	ELECTRIC CABLE SIZE.....	80
9.2	SETTINGS FOR OVERLOAD RELAY AND FUSES.....	81
9.3	REFERENCE CONDITIONS AND LIMITATIONS.....	82
9.4	COMPRESSOR DATA.....	82
10	Instructions for use.....	86
11	Guidelines for inspection.....	87
12	Pressure equipment directives.....	88
13	Declaration of conformity.....	89

1 Safety precautions

1.1 Safety icons

Explanation

	Danger to life
	Warning
	Important note

1.2 General safety precautions

1. The operator must employ safe working practices and observe all related work safety requirements and regulations.
2. If any of the following statements does not comply with the applicable legislation, the stricter of the two shall apply.
3. Installation, operation, maintenance and repair work must only be performed by authorized, trained, specialized personnel. The personnel should apply safe working practices by use of personal protection equipment, appropriate tools and defined procedures.
4. The compressor is not considered capable of producing air of breathing quality. For air of breathing quality, the compressed air must be adequately purified according to the applicable legislation and standards.
5. Before any maintenance, repair work, adjustment or any other non-routine checks:
 - Stop the machine
 - Press the emergency stop button
 - Switch off the voltage
 - Depressurize the machine
 - Lock Out - Tag Out (LOTO):
 - Open the power isolating switch and lock it with a personal lock
 - Tag the power isolating switch with the name of the service technician.
 - On units powered by a frequency converter, wait 10 minutes before starting any electrical repair.
 - Never rely on indicator lamps or electrical door locks before maintenance work, always disconnect and check with measuring device.

	If the machine is equipped with an automatic restart after voltage failure function and if this function is active, be aware that the machine will restart automatically when the power is restored if it was running when the power was interrupted!
---	---

6. Never play with compressed air. Do not apply the air to your skin or direct an air stream at people. Never use the air to clean dirt from your clothes. When using the air to clean equipment, do so with extreme caution and wear eye protection.
7. The owner is responsible for maintaining the unit in safe operating condition. Parts and accessories shall be replaced if unsuitable for safe operation.
8. It is prohibited to walk or stand on the unit or on its components.

9. If compressed air is used in the food industry and more specifically for direct food contact, it is recommended, for optimal safety, to use certified Class 0 compressors in combination with appropriate filtration depending on the application. Please contact your customer center for advice on specific filtration.

1.3 Safety precautions during installation



All responsibility for any damage or injury resulting from neglecting these precautions, or non observance of the normal caution and care required for installation, operation, maintenance and repair, even if not expressly stated, will be disclaimed by the manufacturer.

Precautions during installation

1. The machine must only be lifted using suitable equipment in accordance with the applicable safety regulations. Loose or pivoting parts must be securely fastened before lifting. It is strictly forbidden to dwell or stay in the risk zone under a lifted load. Lifting acceleration and deceleration must be kept within safe limits. Wear a safety helmet when working in the area of overhead or lifting equipment.
2. The unit is designed for indoor use. If the unit is installed outdoors, special precautions must be taken; consult your supplier.
3. In case the device is a compressor, place the machine where the ambient air is as cool and clean as possible. If necessary, install a suction duct. Never obstruct the air inlet. Care must be taken to minimize the entry of moisture at the inlet air.
4. Any blanking flanges, plugs, caps and desiccant bags must be removed before connecting the pipes.
5. Air hoses must be of correct size and suitable for the working pressure. Never use frayed, damaged or worn hoses. Distribution pipes and connections must be of the correct size and suitable for the working pressure.
6. In case the device is a compressor, the aspirated air must be free of flammable fumes, vapors and particles, e.g. paint solvents, that can lead to internal fire or explosion.
7. In case the device is a compressor, arrange the air intake so that loose clothing worn by people cannot be drawn in.
8. Ensure that the discharge pipe from the compressor to the aftercooler or air net is free to expand under heat and that it is not in contact with or close to flammable materials.
9. No external force may be exerted on the air outlet valve; the connected pipe must be free of strain.
10. If remote control is installed, the machine must bear a clear sign stating: DANGER: This machine is remotely controlled and may start without warning.
The operator has to make sure that the machine is stopped and depressurized and that the electrical isolating switch is open, locked and labelled with a temporary warning before any maintenance or repair. As a further safeguard, persons switching on or off remotely controlled machines shall take adequate precautions to ensure that there is no one checking or working on the machine. To this end, a suitable notice shall be affixed to the start equipment.
11. Air-cooled machines must be installed in such a way that an adequate flow of cooling air is available and that the exhausted air does not recirculate to the compressor air inlet or cooling air inlet.

12. The electrical connections must correspond to the applicable codes. The machines must be earthed and protected against short circuits by fuses in all phases. A lockable power isolating switch must be installed near the compressor.
13. On machines with automatic start/stop system or if the automatic restart function after voltage failure is activated, a sign stating "This machine may start without warning" must be affixed near the instrument panel.
14. In multiple compressor systems, manual valves must be installed to isolate each compressor. Non-return valves (check valves) must not be relied upon for isolating pressure systems.
15. Never remove or tamper with the safety devices, guards or insulation fitted on the machine. Every pressure vessel or auxiliary installed outside the machine to contain air above atmospheric pressure must be protected by a pressure relieving device or devices as required.
16. Piping or other parts with a temperature in excess of 70°C (158°F) and which may be accidentally touched by personnel in normal operation must be guarded or insulated. Other high temperature piping must be clearly marked.
17. For water-cooled machines, the cooling water system installed outside the machine has to be protected by a safety device with set pressure according to the maximum cooling water inlet pressure.
18. If the ground is not level or can be subject to variable inclination, consult the manufacturer.
19. If the device is a dryer and no free extinguishing system is present in the air net close to the dryer, safety valves must be installed in the vessels of the dryer.



Also consult following safety precautions: [Safety precautions during operation](#) and [Safety precautions during maintenance](#).
 These precautions apply to machinery processing or consuming air or inert gas. Processing of any other gas requires additional safety precautions typical to the application which are not included herein.
 Some precautions are general and cover several machine types and equipment; hence some statements may not apply to your machine.

1.4 Safety precautions during operation



All responsibility for any damage or injury resulting from neglecting these precautions, or non observance of the normal caution and care required for installation, operation, maintenance and repair, even if not expressly stated, will be disclaimed by the manufacturer.

Precautions during operation

1. Never touch any piping or components of the machine during operation.
2. Use only the correct type and size of hose end fittings and connections. When blowing through a hose or air line, ensure that the open end is held securely. A free end will whip and may cause injury. Make sure that a hose is fully depressurized before disconnecting it.
3. Persons switching on remotely controlled machines shall take adequate precautions to ensure that there is no one checking or working on the machine. To this end, a suitable notice shall be affixed to the remote start equipment.
4. Never operate the machine when there is a possibility of taking in flammable or toxic fumes, vapors or particles.
5. Never operate the machine below or in excess of its limit ratings.

6. Keep all bodywork doors shut during operation. The doors may be opened for short periods only, e.g. to carry out routine checks. Wear ear protectors when opening a door. On machines without bodywork, wear ear protection in the vicinity of the machine.
7. People staying in environments or rooms where the sound pressure level reaches or exceeds 80 dB(A) shall wear ear protectors.
8. Periodically check that:
 - All guards are in place and securely fastened
 - All hoses and/or pipes inside the machine are in good condition, secure and not rubbing
 - No leaks occur
 - All fasteners are tight
 - All electrical leads are secure and in good order
 - Safety valves and other pressure relief devices are not obstructed by dirt or paint
 - Air outlet valve and air net, i.e. pipes, couplings, manifolds, valves, hoses, etc. are in good repair, free of wear or abuse
 - Air cooling filters of the electrical cabinet are not clogged
9. If warm cooling air from compressors is used in air heating systems, e.g. to warm up a workroom, take precautions against air pollution and possible contamination of the breathing air.
10. On water-cooled compressors using open circuit cooling towers, protective measures must be taken to avoid the growth of harmful bacteria such as Legionella pneumophila bacteria.
11. Do not remove any of, or tamper with, the sound-damping material.
12. Never remove or tamper with the safety devices, guards or insulations fitted on the machine. Every pressure vessel or auxiliary installed outside the machine to contain air above atmospheric pressure shall be protected by a pressure relieving device or devices as required.
13. Yearly inspect the air receiver. Minimum wall thickness as specified in the instruction book must be respected. Local regulations remain applicable if they are more strict.



Also consult following safety precautions: [Safety precautions during installation](#) and [Safety precautions during maintenance](#).

These precautions apply to machinery processing or consuming air or inert gas. Processing of any other gas requires additional safety precautions typical to the application which are not included herein.

Some precautions are general and cover several machine types and equipment; hence some statements may not apply to your machine.

1.5 Safety precautions during maintenance or repair



All responsibility for any damage or injury resulting from neglecting these precautions, or non observance of the normal caution and care required for installation, operation, maintenance and repair, even if not expressly stated, will be disclaimed by the manufacturer.

Precautions during maintenance or repair

1. Always use the correct safety equipment (such as safety glasses, gloves, safety shoes, etc.).
2. Use only the correct tools for maintenance and repair work.

3. Use only genuine spare parts for maintenance or repair. The manufacturer will disclaim all damage or injuries caused by the use of non-genuine spare parts.
4. All maintenance work shall only be undertaken when the machine has cooled down.
5. A warning sign bearing a legend such as "Work in progress; do not start" shall be attached to the starting equipment.
6. Persons switching on remotely controlled machines shall take adequate precautions to ensure that there is no one checking or working on the machine. To this end, a suitable notice shall be affixed to the remote start equipment.
7. Close the compressor air outlet valve and depressurize the compressor before connecting or disconnecting a pipe.
8. Before removing any pressurized component, effectively isolate the machine from all sources of pressure and relieve the entire system of pressure.
9. Never use flammable solvents or carbon tetrachloride for cleaning parts. Take safety precautions against toxic vapors of cleaning liquids.
10. Scrupulously observe cleanliness during maintenance and repair. Keep dirt away by covering the parts and exposed openings with a clean cloth, paper or tape.
11. Never weld or perform any operation involving heat near the oil system. Oil tanks must be completely purged, e.g. by steam cleaning, before carrying out such operations. Never weld on, or in any way modify, pressure vessels.
12. Whenever there is an indication or any suspicion that an internal part of a machine is overheated, the machine shall be stopped but no inspection covers shall be opened before sufficient cooling time has elapsed; this to avoid the risk of spontaneous ignition of the oil vapor when air is admitted.
13. Never use a light source with open flame for inspecting the interior of a machine, pressure vessel, etc.
14. Make sure that no tools, loose parts or rags are left in or on the machine.
15. All regulating and safety devices shall be maintained with due care to ensure that they function properly. They may not be put out of action.
16. Before clearing the machine for use after maintenance or overhaul, check that operating pressures, temperatures and time settings are correct. Check that all control and shut-down devices are fitted and that they function correctly. If removed, check that the coupling guard of the compressor drive shaft has been reinstalled.
17. Every time the separator element is renewed, examine the discharge pipe and the inside of the oil separator vessel for carbon deposits; if excessive, the deposits should be removed.
18. Protect the motor, air filter, electrical and regulating components, etc. to prevent moisture from entering them, e.g. when steam cleaning.
19. Make sure that all sound-damping material and vibration dampers, e.g. damping material on the bodywork and in the air inlet and outlet systems of the compressor, is in good condition. If damaged, replace it by genuine material from the manufacturer to prevent the sound pressure level from increasing.
20. Never use caustic solvents which can damage materials of the air net, e.g. polycarbonate bowls.
21. **Only if applicable, the following safety precautions are stressed when handling refrigerant:**
 - Never inhale refrigerant vapors. Check that the working area is adequately ventilated; if required, use breathing protection.
 - Always wear special gloves. In case of refrigerant contact with the skin, rinse the skin with water. If liquid refrigerant contacts the skin through clothing, never tear off or remove the latter; flush abundantly with fresh water over the clothing until all refrigerant is flushed away; then seek medical first aid.



Also consult following safety precautions: [Safety precautions during installation](#) and [Safety precautions during operation](#).
These precautions apply to machinery processing or consuming air or inert gas. Processing of any other gas requires additional safety precautions typical to the application which are not included herein.
Some precautions are general and cover several machine types and equipment; hence some statements may not apply to your machine.

1.6 Dismantling and disposal

Dismantling

Once the end of life of the machine is reached, please follow next steps:

1. Stop the machine.
2. Check all safety precautions mentioned in the previous chapters to secure safe handling (e.g. LOTO, cool-down, depressurize, discharge, ...).
3. Separate the harmful from the safe components (e.g. drain oil from oil containing parts).
4. Refer to the disposal topic mentioned below.

Disposal of electrical and electronic appliances (WEEE)

This equipment falls under the provisions of the European Directive 2012/19/EU on waste electrical and electronic appliances (WEEE) and may not be disposed as unsorted waste.



The equipment is labelled in accordance with the European Directive 2012/19/EU with the crossed-out wheeled bin symbol.

At the end of life-time of the electric and electronic equipment (EEE) it must be taken to separate collection.

For more information check with your local waste authority, customer center or distributor.

Disposal of other used material

Used filters or any other used material (e.g. filter bags, filter media, desiccant, lubricants, cleaning rags, machine parts, etc.) must be disposed of in an environmentally friendly and safe manner, and in line with the local recommendations and environmental legislation.

2 General description

2.1 Introduction

Introduction

G 2, G 3, G 4, G 5 and G 7 are air-cooled, single-stage, oil-injected screw compressors, driven by an electric motor.

The compressors are belt driven.

The compressors are enclosed in sound-insulating bodywork.

An easy-to-operate control panel is provided, including the electronic Base controller and the emergency stop button. A cabinet housing the controller, pressure sensor and motor starter is integrated into the bodywork.

Pack versions do not include an air dryer.

Full-Feature versions are fitted with an air dryer (DR). The dryer removes moisture from the compressed air by cooling the air to near the freezing point and automatically draining the condensate.

Floor-mounted model

The compressor is installed directly on the floor.



86119D

G 5, floor-mounted

Ref.	Description
1	Electric cabinet

Tank-mounted model

Tank-mounted units are supplied with an air receiver of 200 l (52.80 US gal / 44 Imp gal / 7 cu.ft) or 500 l (132 US gal / 110 Imp gal / 17.50 cu.ft) and are available in Pack and Full-Feature version.

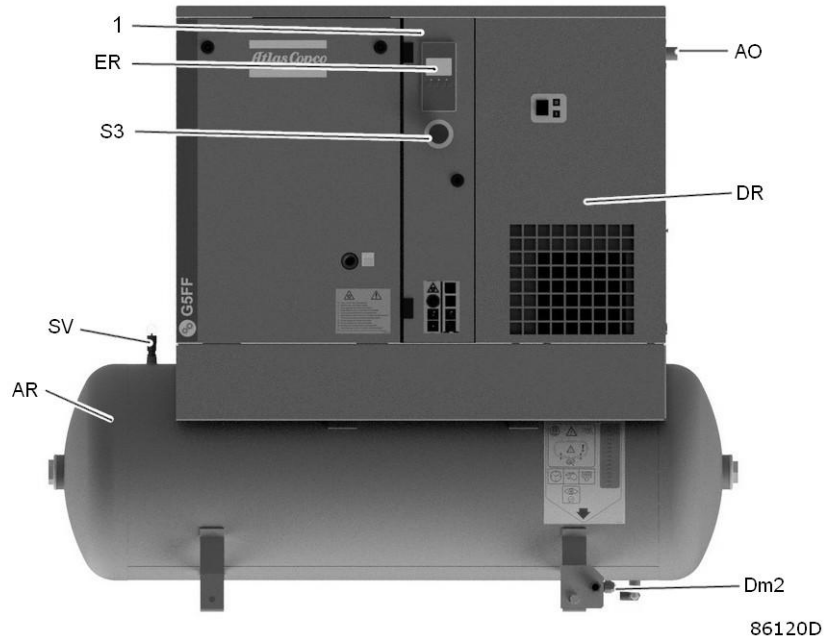

G 5, Full-Feature, tank-mounted

Ref.	Description
1	Electric cabinet
ER	Elektronikon™ Base controller
S3	Emergency stop button
AO	Air outlet
AR	Air receiver
Dm2	Manual condensate drain valve, air receiver
SV	Safety valve
DR	Integrated dryer

2.2 Air flow

Pack

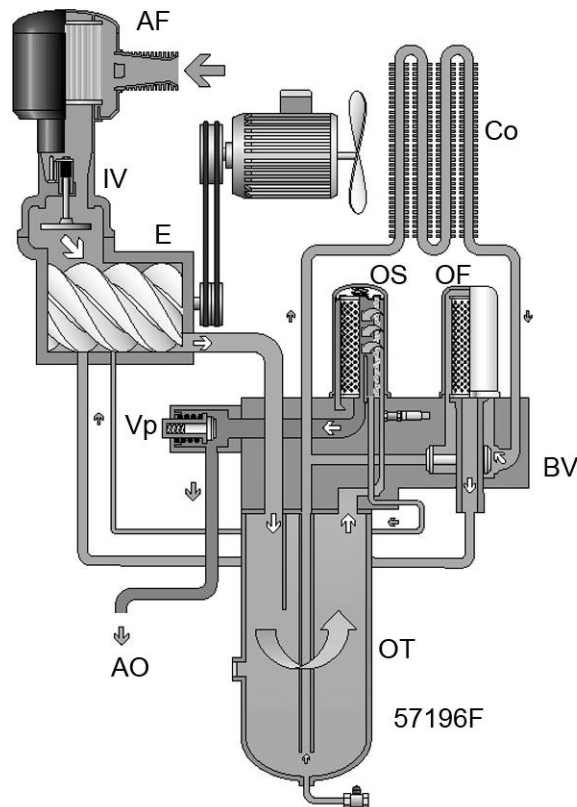

Air flow, floor-mounted Pack units

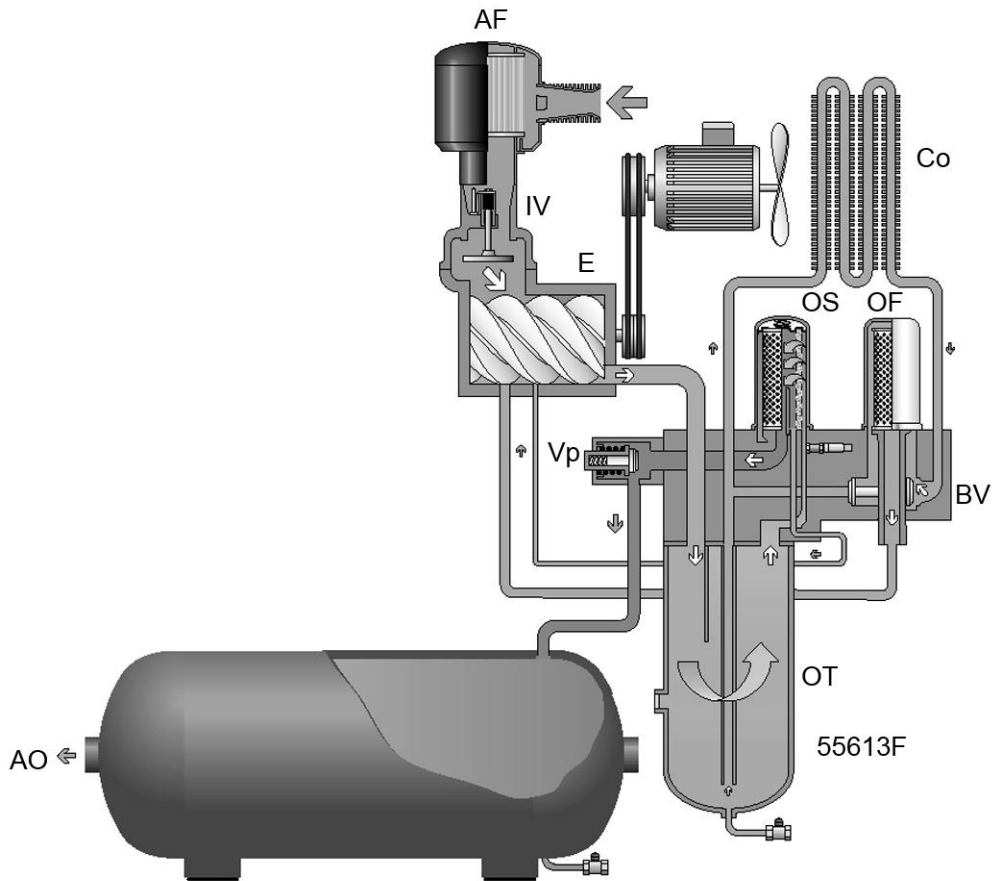

Air flow, tank-mounted Pack units

Air drawn in through air filter (AF) and open inlet valve (IV) is compressed in compressor element (E). Compressed air and oil flow into oil separator/tank (OT) where most of the oil is removed by centrifugal action. The remaining oil is removed by oil separator (OS). The air flows to the outlet (AO) via minimum pressure valve (Vp).

Full-Feature

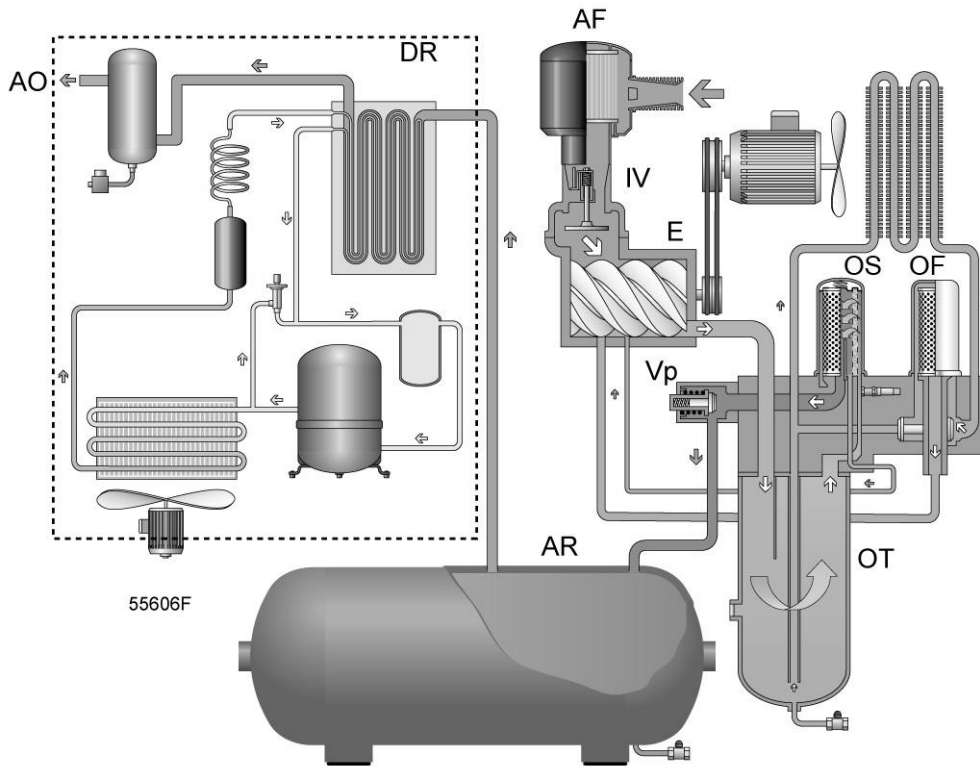

Air flow, tank-mounted Full-Feature units

Air drawn in through air filter (AF) and open inlet valve (IV) is compressed in compressor element (E). Compressed air and oil flow into oil separator/tank (OT) where most of the oil is removed by centrifugal action. The remaining oil is removed by oil separator (OS). The air is discharged via minimum pressure valve (Vp), air receiver (AR) and dryer (DR) towards the air outlet (AO).

2.3 Oil system

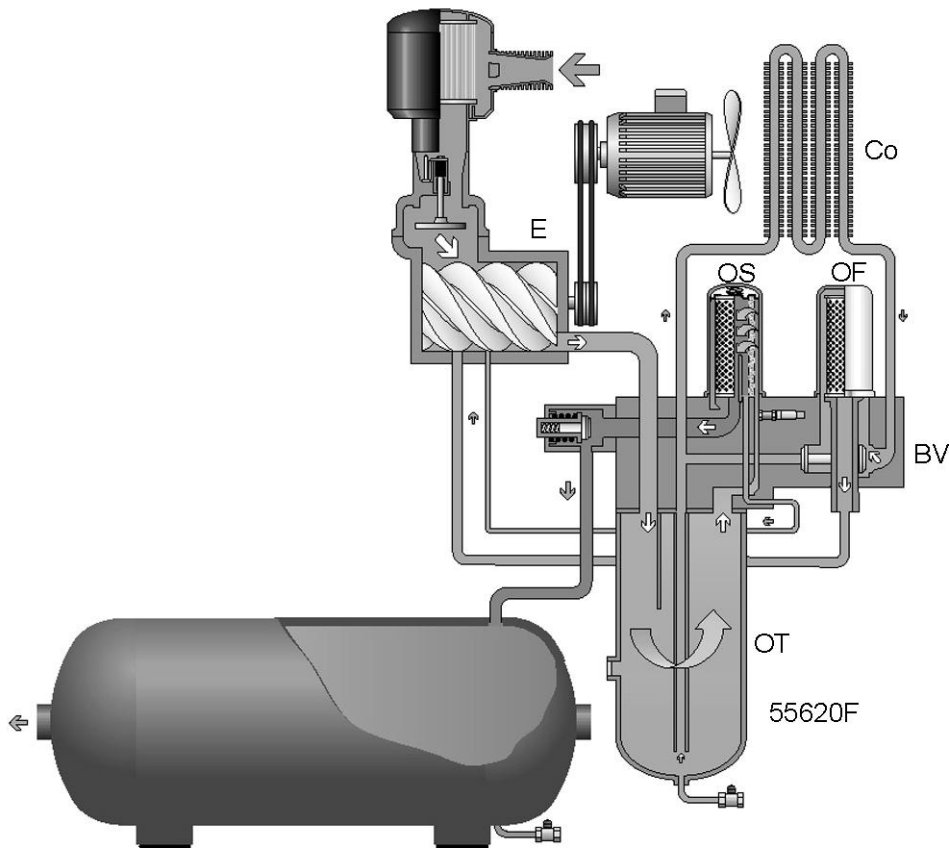

Oil system, Pack

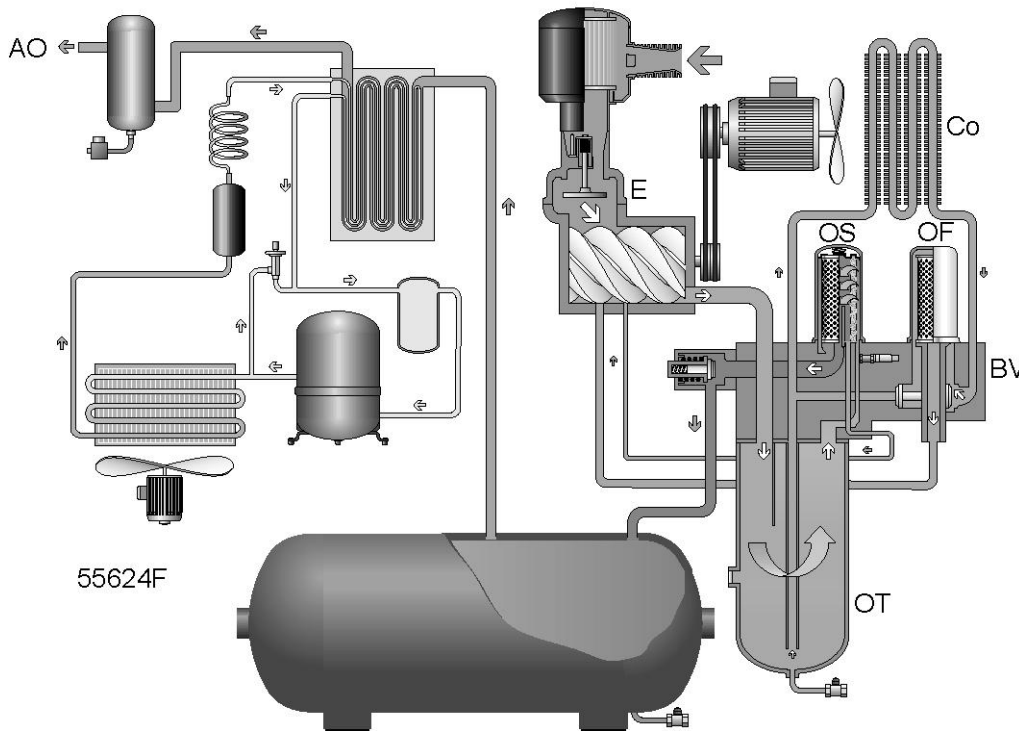

Oil system, Full-Feature

Air pressure in the oil separator tank (OT) forces the oil from the tank to compressor element (E) via oil cooler (Co) and oil filter (OF). Compressed air and oil flow into oil separator/tank (OT) where most of the oil is separated from the air by centrifugal action. The remaining oil is removed by oil separator (OS) and returns to the oil circuit via a separate line. The minimum pressure valve (Vp - see section [Air flow](#)) ensures a minimal pressure in the tank, required for oil circulation under all circumstances.

The oil circuit has a thermostatic bypass valve (BV). When the oil temperature is below the set-point of the valve, the by-pass valve shuts off the oil supply from oil cooler. The by-pass valve starts opening the supply from cooler (Co) when the oil temperature exceeds the setting of the valve. The setting of the by-pass valve depends on the model. See section Compressor data. In the oil separator vessel, there might be formation of condensation, especially if the unit is oversized, run with load duty cycle or in an environment with high RH. If necessary, the condensation must be checked and removed on a regular basis through the manual drain valve, in order to prevent water-related damages on the elements of the oil circuit (see section [Preventive maintenance schedule](#)).

2.4 Cooling system

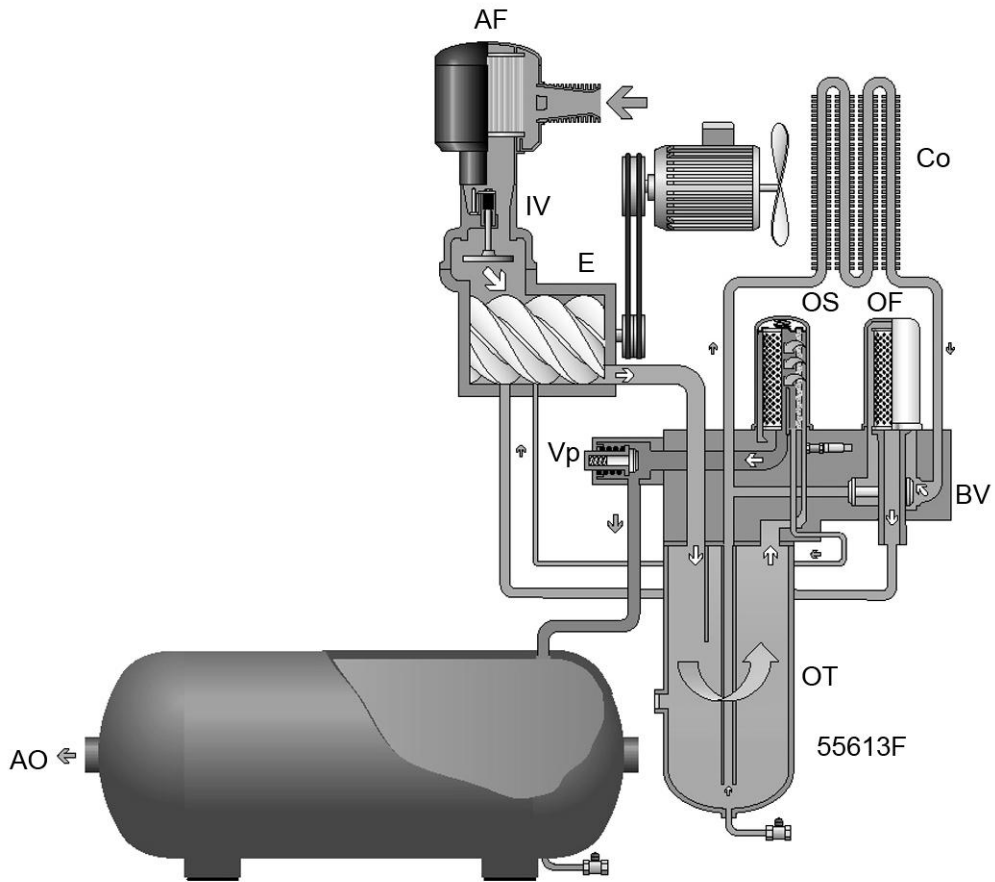

Pack units

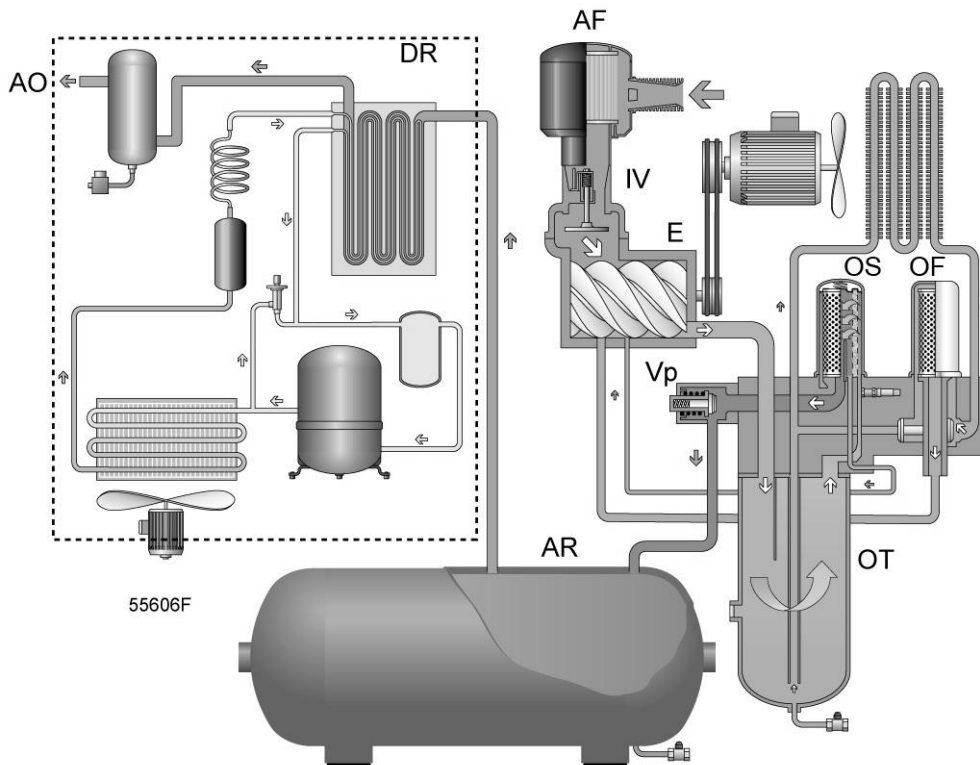

Full-Feature units

The cooling system of the Pack version comprises oil cooler (Co) and fan (FN). The fan, mounted directly onto the motor shaft, generates the cooling air in order to cool the oil and the internal parts of the compressor. On tank-mounted compressors, the air receiver is used as air cooler. The condensate must be drained manually on a regular basis, see section [Preventive maintenance schedule](#).

The dryer (DR) of Full-Feature versions has a separate cooling fan and an automatic condensate drain (see also section [Air dryer](#)).

2.5 Regulating system

G 2 up to G 4

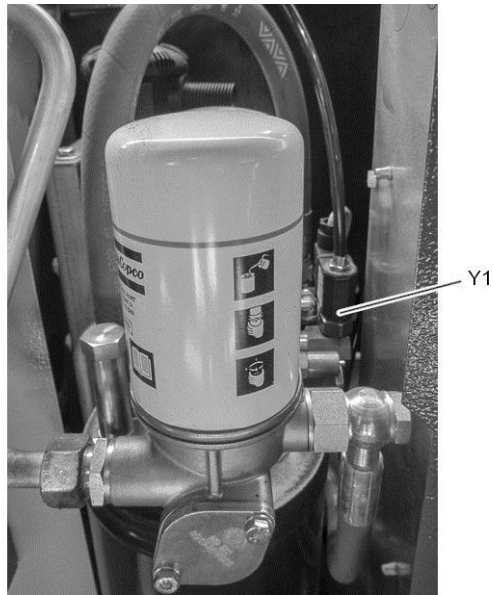

86121D

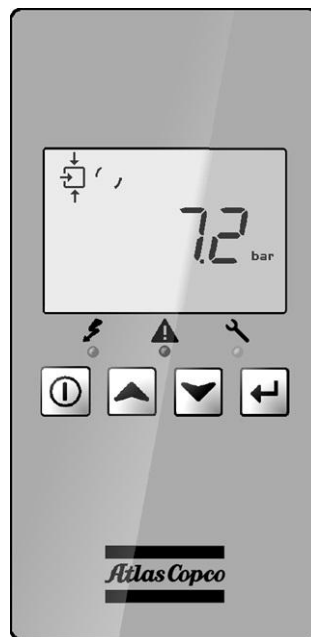

84698D

The main components of the regulating system are:

- Blow-off valve (Y1)
- The Elektronikon™ Base controller that starts/stops the compressor based on the pressure settings and readings of the pressure sensor.

As long as the working pressure is below the preset maximum, the compressor will run fully loaded (100% output) and the blow-off valve will be closed. When the working pressure reaches the maximum limit, the Base controller stops the main motor and opens the blow-off valve. The

compressor will automatically restart and then the blow-off valve will be closed, when the net pressure drops to the minimum limit set in the controller.

G 5 up to G 7

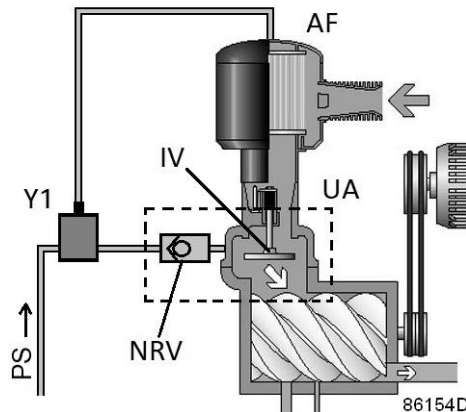

The main components of the regulating system are:

- Unloader (UA), including inlet valve (IV) and non-return valve (NRV).
- Loading solenoid valve (Y1), normally open.
- Pressure signal (PS) from the instrument block.
- The Elektronikon™ Base controller that regulates the compressor based on the pressure settings and readings of the pressure sensor.

Loading

If the working pressure is below the preset maximum, the solenoid valve (Y1) is energized and therefore closed. There is no signal air flow into unloader allowing the inlet valve to open due to the element suction.

The inlet valve opens completely allowing the air through the air filter (AF) and the compressor will run fully loaded (100% output).

The unit stops loading when the set 'Unload' pressure is reached, the machine will run unloaded.

Unloading

When the working pressure reaches the unload pressure, solenoid valve (Y1) is de-energized and therefore open. The signal air flow goes directly through the non-return valve (NRV) into the unloader (UA), keeping the inlet valve closed. The compressor will run unloaded (0% output) and the pressure is discharged into the air filter (AF).

The compressors are equipped with the Elektronikon™ Base controller, an intelligent controller that will stop the compressor after a variable period of unloaded operation using the following control algorithm:

- At power on, in the first work cycle, the 'Unload' period is 30 seconds.
- If the compressor is stopped manually, it stops after 30 seconds of unloaded operation.
- After the first work cycle, and in all other working cycles, the 'Unload' period is calculated following 3 main rules:
 - a. The compressor cannot go over the number of hourly activations. Given a maximum number of 10 restarts per hour (factory setting), the total running period per cycle ('Load' time + 'Unload' time) must be minimum 6 minutes (360s).

- b. If the calculated virtual temperature of the motor (which increases each motor start) is above the safety limit, the compressor will go in unload mode until the temperature is decreased below the safety limit.
- c. At the end of the unload period the controller checks the pressure. If there is no pressure request at the end of the cycle and the pressure is above 2/3 of the pressure band, the compressor stops. If there is a pressure request at the end of the cycle and the pressure is below 2/3 of the pressure band, the compressor goes into loading mode.

If the unit is restarting frequently, or is manually restarted by the operator, the controller will extend the unload period in order to ensure proper motor cooling. This overrules the standard unload period.

The compressor will automatically restart when the net pressure drops to the minimum limit. In order to avoid that the pressure in the compressed air distribution piping drops below the minimum set value, the compressor in stand-by will restart at 0,2 bar (3 psi) over the loading pressure.

2.6 Control panel

Control panel

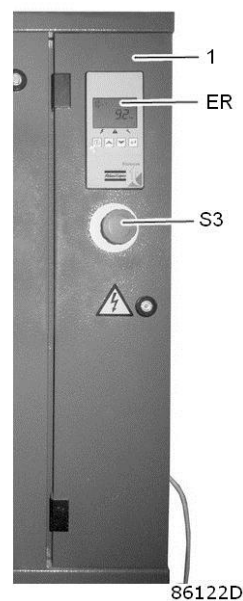

Control panel, Pack

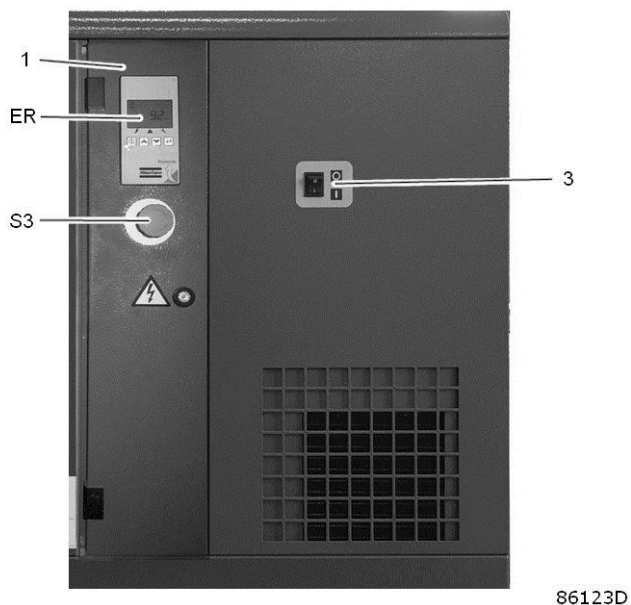

Control panel, Full-Feature

Reference	Designation
1	Electric cabinet
ER	Elektronikon™ Base controller
S3	Emergency stop button
3	Dryer switch (Full-Feature)

2.7 Electrical system

Electrical components

The electrical system comprises the following components:

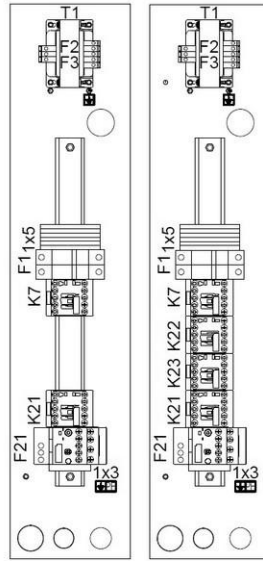

86124D

Electric cubicle IEC (DOL and YD)

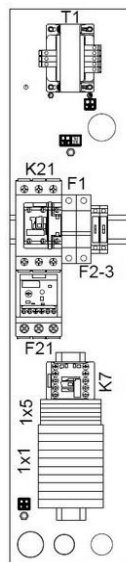

86125D

Electric cubicle UL/CSA (only DOL)

Reference	Designation
F1-3	Fuses
F21	Overload relay, compressor motor
K7	Auxiliary circuit relay
K21	Line contactor
K22	Star contactor
K23	Delta contactor
T1	Transformer
1x1	Terminal block, voltage change of the motor (only on tri-voltage units)

Reference	Designation
1x3	Terminal block of earth protection
1x5	Terminal block of control unit

Electrical diagram

2205 0161 00	Service diagram G 2 – G 3 – G 4 DOL IEC
2205 0161 50	Service diagram G 4 – G 5 – G 7 YD IEC
2205 0347 00	Service diagram G 2 – G 4 – G 5 – G 7 DOL UL
2205 0347 50	Service diagram G 2 – G 4 – G 5 – G 7 DOL CSA

The complete electrical diagram can be found in the electric cubicle.

The complete electrical diagram can be found on the USB supplied with the machine.

2.8 Protection of the compressor



86126D

Safety valve on the compressor

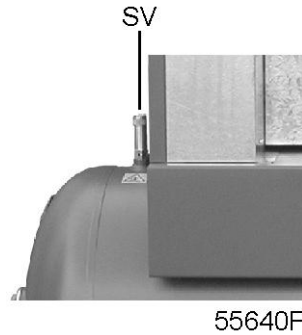

Safety valve on the air receiver (tank-mounted units)

Reference	Designation	Function
SV	Safety valve	To protect the air outlet system if the outlet pressure exceeds the opening pressure of the valve.

2.9 Air dryer

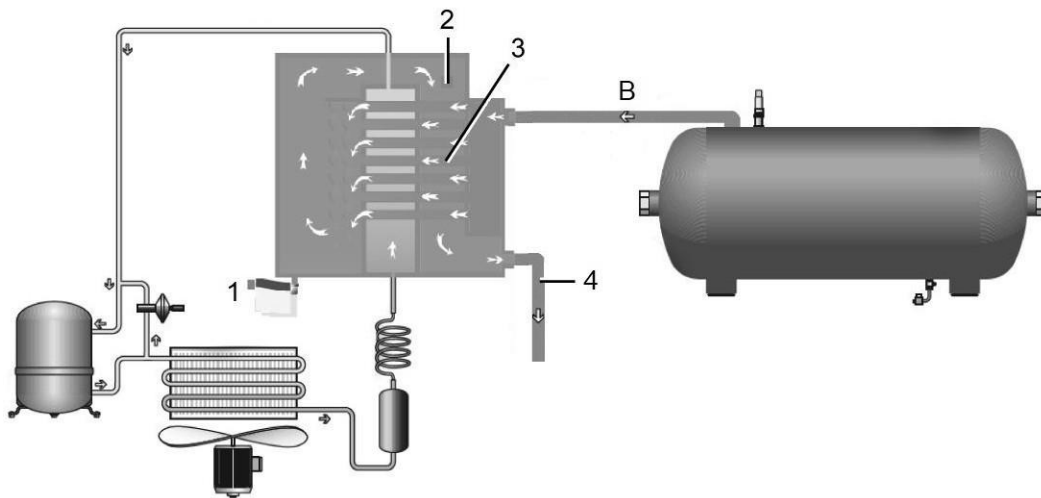

86127D

Air Dryer

Wet compressed air (B) enters the dryer. The air then flows through heat exchanger (2) where refrigerant evaporates, withdrawing heat from the air. The cold air then flows through a condensate trap (1) which separates condensate from the air. The condensate is automatically drained. The cold, dried air then flows through the heat exchanger (3), where it is warmed up by the incoming air, then finally discharged from the dryer outlet (4).

3 Controller

3.1 Controller

Control panel

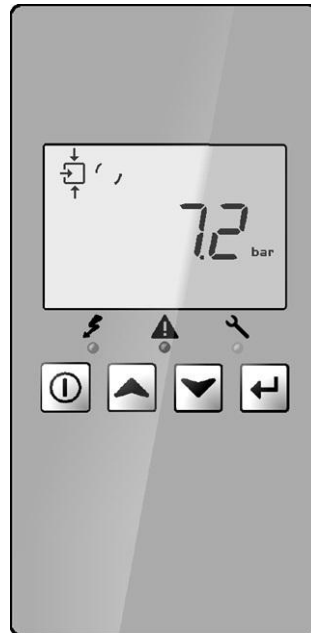

84891D

Introduction

In general, the controller has the following functions:

- Controlling the compressor;
- Protecting the compressor;
- Monitoring service intervals;
- Automatic restart after voltage failure (made inactive);

Automatic control of the compressor

For 2.2 - 4 kW (3 - 5.5 HP) units, the controller automatically switches the units on/off to maintain pressure in the desired range.

For 5.5 - 7.5 kW (7.5 - 10 HP) units, the controller maintains the net pressure between programmable limits by automatically loading and unloading the compressor. A number of programmable settings are taken into account, e.g. the unloading and loading pressures, the minimum stop time and the maximum number of motor starts. The controller stops the compressor whenever possible to reduce power consumption and restarts it automatically when net pressure decreases. If the expected unloading period is too short, the compressor is kept running to prevent too short standstill periods.

Protecting the compressor

Shutdown temperature warning

The shutdown temperature warning is a programmable warning that advises the operator that the shutdown temperature is nearly reached. If the measured temperature exceeds the programmed shutdown warning temperature, this will be indicated on the controller display before the shutdown temperature is reached.

Shutdown

If the compressor element outlet temperature exceeds the programmed shutdown level or the overload relay of the main motor trips, the compressor will be stopped. This will be indicated on the display of the controller.

Service warning

If the service timer exceeds the preset value, the controller advises the operator via the display, to carry out the service maintenance.

Automatic restart after voltage failure

The controller has a built-in function to automatically restart the compressor when the voltage is restored after voltage failure. This function is deactivated on compressors leaving the factory.

Remote control

This function allows the compressor to start/stop with an external switch signal. Activation can only be done by your supplier.



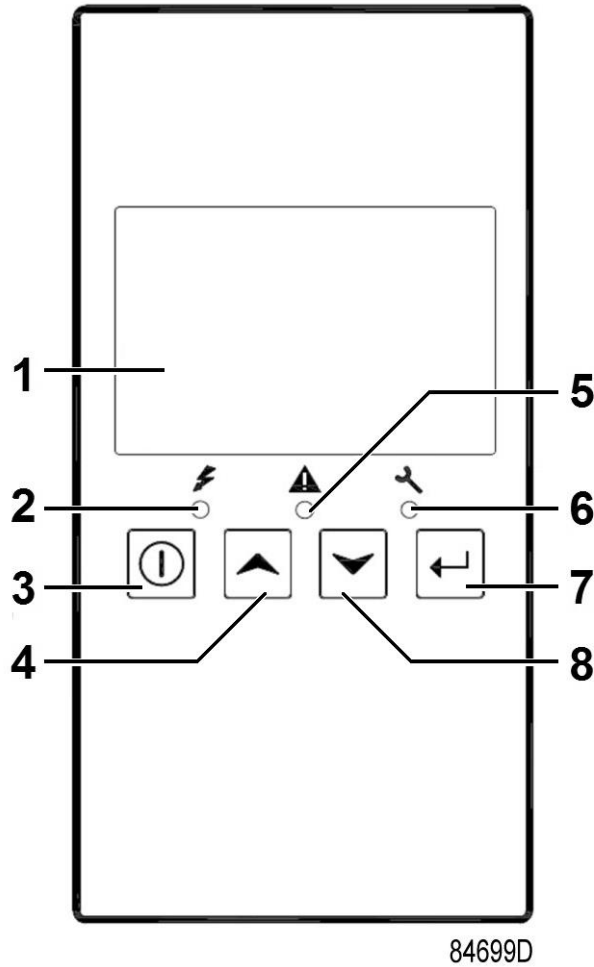

Please contact your supplier for further details.





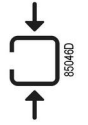
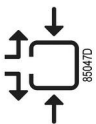
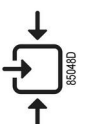



3.2 Control panel



Reference	Designation	Function
1	Display	Shows icons and operating conditions.
2	LED, Voltage on	Indicates that the voltage is switched on.
3	Start/stop button	Keep pressed for 3 seconds to start compressor. Press to stop compressor if running. Use this button to go to previous screen or to end the current action.
4	Scroll button	Use these buttons to scroll through the menu.
5	LED, Warning	Is lit if a warning condition exists.
6	LED, Service	Is lit when service is needed.
7	Enter button	Press 3 seconds to enter in menu. Use this button to confirm the last action. Press 5 seconds to reset alarm.
8	Scroll button	Use these buttons to scroll through the menu.

3.3 Icons used on the display

Function	Icon	Description
Stopped/Running		When the compressor is stopped, the icon stands still. When the compressor is running, the icon is rotating.
Compressor status		Motor stopped
		Running unloaded Running unloaded (blinking for manual stop) Only for 5.5 - 7.5 kW (7.5 - 10 HP) units.
		Running loaded
Machine control mode		Remote start/stop active
Automatic restart after voltage failure		Automatic restart after voltage failure is active
Active protection functions		Emergency stop
Service		Service required

Function	Icon	Description
Units	 MPa 85057D	Pressure unit (Mega Pascal)
	 psi 85068D	Pressure unit (pounds per square inch)
	 bar 85061D	Pressure unit (bar)
	 °C 85069D	Temperature unit (degree Centigrade)
	 °F 85090D	Temperature unit (degree Fahrenheit)
	 Motor 85055D	Motor
	 x1000 hrs 85056D	A time/delay parameter is displayed. NOTE: <ul style="list-style-type: none"> • x1000: ON if the displayed value is in thousands of • hrs: ON if the displayed value is in hours • s: ON if the displayed value is in seconds
	 Element outlet temperature 85051D	Element outlet temperature

3.4 Main screen

At power on, the first screen is a test screen (Icon, digit and led are on). The next screen is the Main screen, shown automatically. The Main screen shows:

- The compressor status by means of pictographs;
- The air outlet pressure;

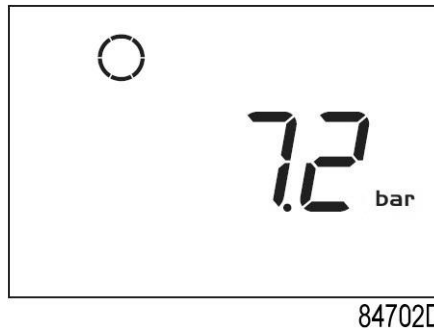

Main screen with pressure (stopped compressor)

From the Main screen it is possible with up and down buttons (4-8) to change the view from pressure to temperature of the element outlet.

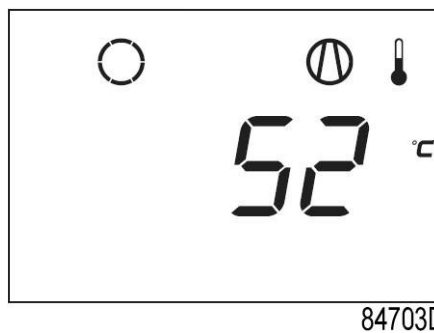

Main screen with temperature (stopped compressor)

3.5 Main function

To switch on the compressor, press the start/stop button (3) for 3 seconds. The compressor starts and the status is shown:

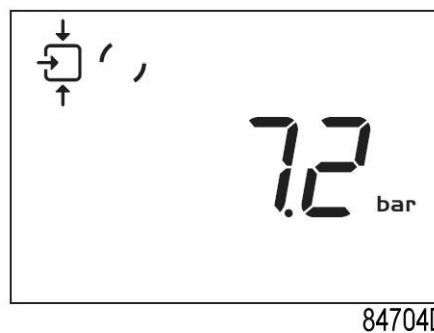

Screen with running compressor

To stop the compressor, push the start/stop button (3). The compressor immediately unloads (only for 5.5 - 7.5 kW units) or stops (2.2 - 4 kW units):

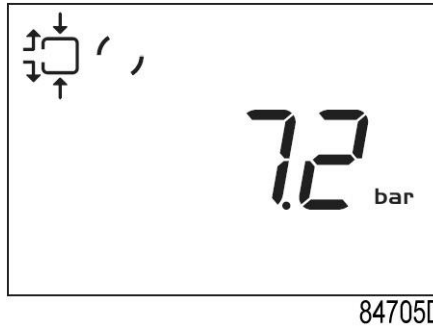

Screen with unloading compressor

After the unload time has elapsed (only for 5.5 - 7.5 kW units), the compressor is stopped, and the controller goes back to the main screen:

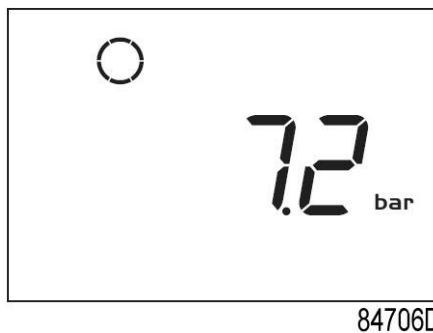

Main screen with pressure (stopped compressor)

To enter the main menu (starting from the Main screen), press the enter button (7) for 3 seconds. The main menu is shown:



First screen of main menu

It is possible to scroll in the menu with the up or down buttons (4-8). To select one item push the enter button (7). To end the current action push start/stop (3) button.

If the emergency stop button is pushed, the compressor stops immediately and the following screen will appear:

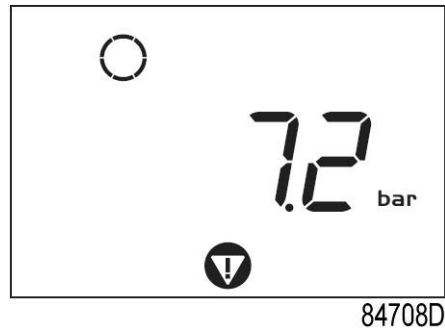

Emergency stop

When the emergency push button is restored, reset the alarm by pressing the enter button (7) for 5 seconds. The following screen will appear:

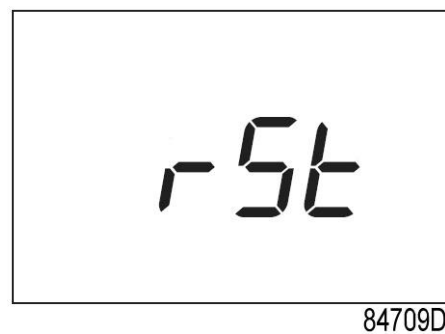

Alarm reset

3.6 Shutdown warning

Description

A shutdown warning will appear in the event of:

- A too high temperature at the outlet of the compressor element.

Compressor element outlet temperature

- If the outlet temperature of the compressor element exceeds the shutdown warning level (factory set at 110°C/ 230°F), warning LED (5) is on.
- Press Scroll up or down buttons (4-8). The screen shows the temperature at the compressor element outlet.

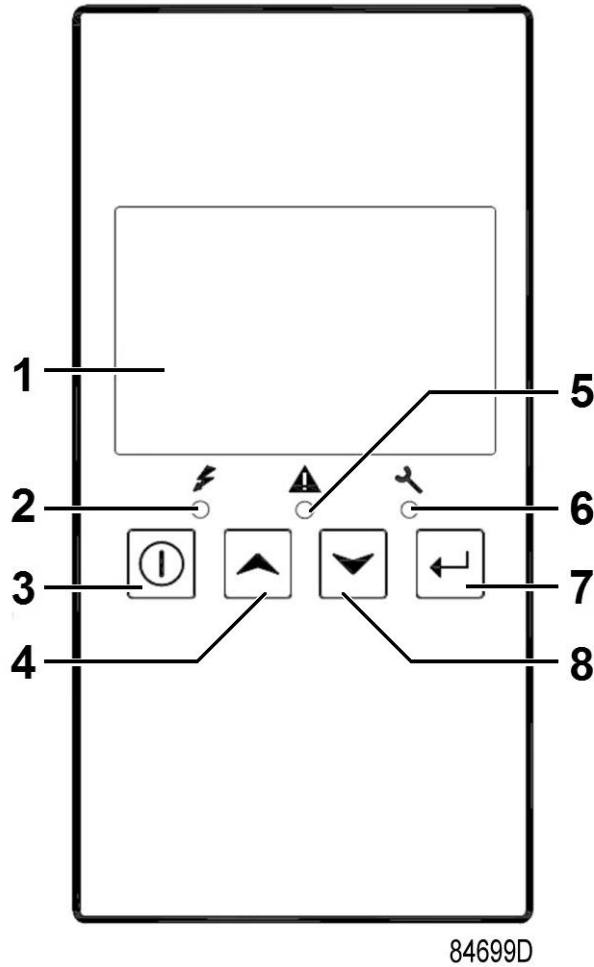

It remains possible to check the actual status of other parameters by pressing the enter button (7) for 3 seconds. Press button (3) to stop the compressor and wait until the compressor has stopped. The warning message will disappear as soon as the warning condition disappears.

3.7 Shutdown

Description

The compressor will stop:

- In case the temperature at the outlet of the compressor element exceeds the shutdown level, detected by the temperature sensor or by the temperature switch.
- In case of error of the outlet pressure sensor or temperature sensor.
- In case of overload of the compressor motor.

Compressor element outlet temperature

If the outlet temperature of the compressor element exceeds the shutdown level (factory setting 115°C/239°F):

- The compressor will stop.
- Alarm LED (5) will flash.
- The following screen will appear:

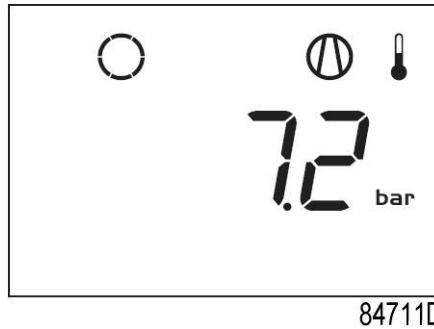

Main screen with shutdown indication, element outlet temperature

- The related pictograph



will appear flashing.

- Scroll Up or Down buttons (4-8) until the current element outlet temperature appears.

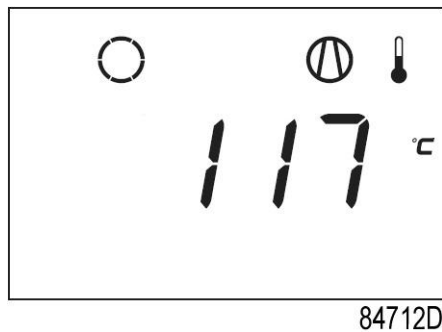

Shutdown screen, element outlet temperature

The screen shows that the temperature at the outlet of the compressor element is 117 °C.

- When the shutdown condition has been solved, press the Enter button (7) for 5 seconds.
- When <rSt> appears on the display, the compressor can be restarted.

Error pressure/temperature sensor

In the event of an error of the outlet pressure sensor (PT20) or temperature sensor (TT11):

- The compressor will stop.
- The following screen will appear:

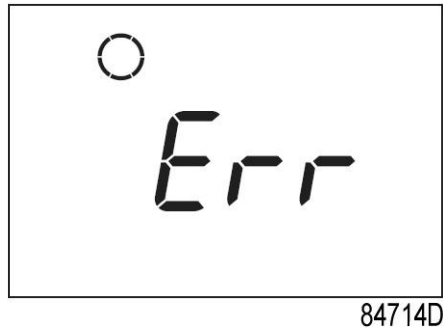

Example of error sensor

Motor overload

In the event of motor overload:

- The compressor will stop.
- Alarm LED (5) will flash.
- The following screen will appear:

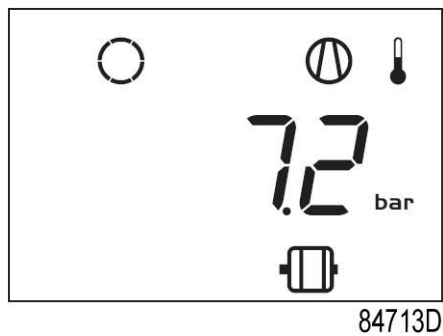

Main screen with shutdown indication, motor overload

- Contact your supplier for fault troubleshooting
- When the shutdown condition has been solved, press the enter button (7) for 5 seconds.
- When <rSt> appears on the display, the compressor can be restarted.

3.8 Service warning

Description

A service warning will appear when the service timer has reached the preset time interval.

If the service timer exceeds the programmed time interval, alarm LED (6) is blinking with a following screen:

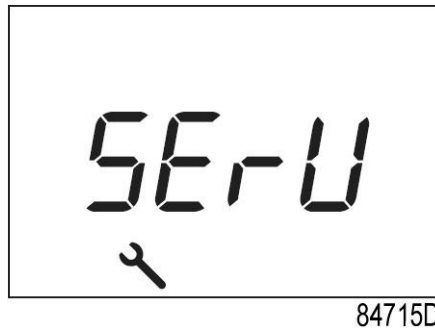

Blinking screen

- Press Enter button (7) to enter the main menu.
- Select <dAtA> and press Enter button (7) to enter the data menu.
- Scroll (buttons 4-8) until <d.6> and the service symbol is shown.
- Press enter button (7).
- The actual reading of the service timer is shown in <hrs>.



Example of running hours screen

The example screen shows that the service timer is at 2002 hours.

Stop the compressor, switch off the voltage and carry out the required service actions.

After servicing, reset the service timer.

See section [Calling up/resetting the service timer](#).

3.9 Scrolling through all screens

Control panel

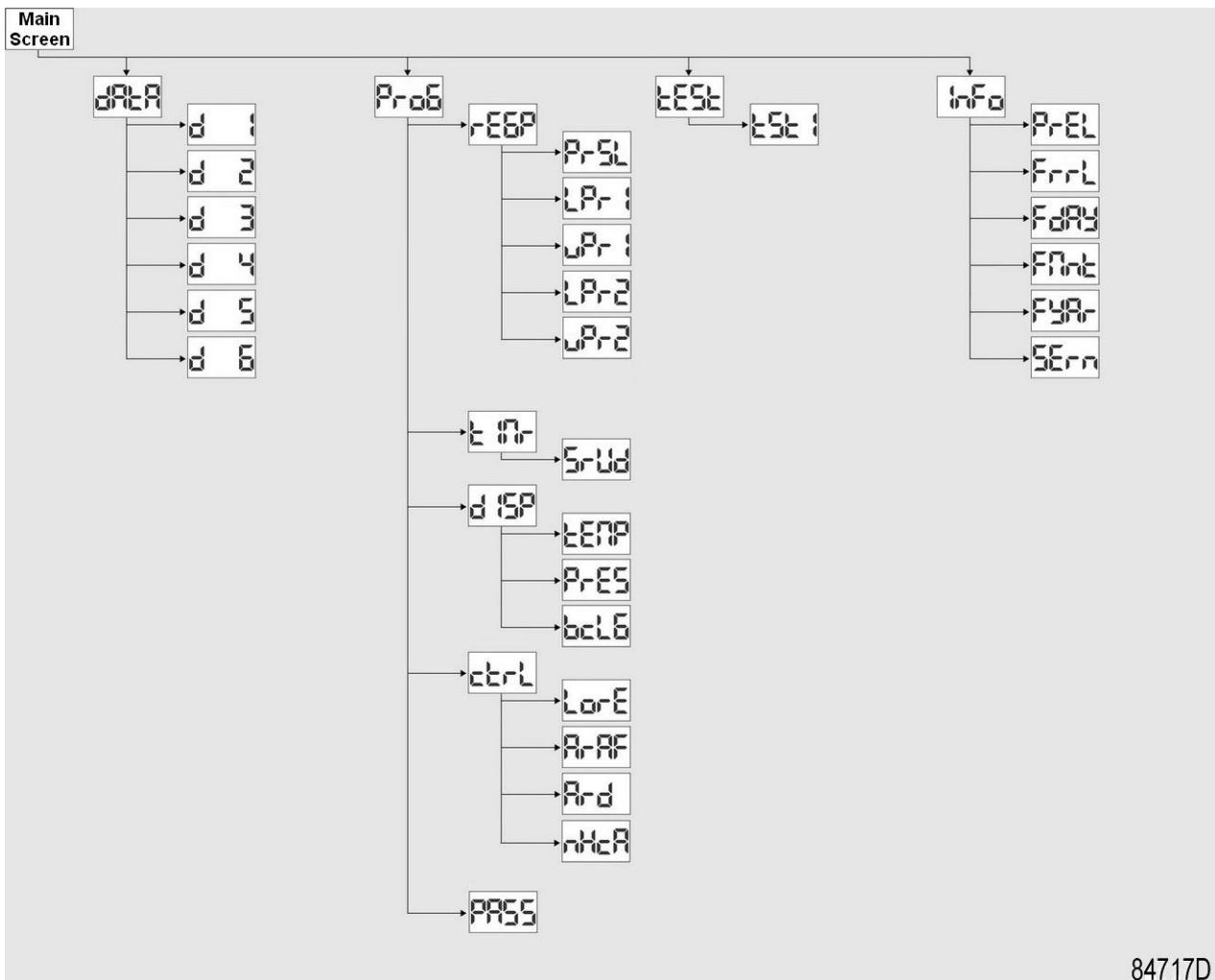

84717D

General overview of the menu structure

From the Main screen press the enter button (7) for 3 seconds to enter the Menu. You will find the following items:

dAtA	Data counters parameters.
ProG	Submenu of Regulation pressure, Timer, Display setting and Control setting.
tEST	Display test.
InFo	Information of firmware release.

Overview of the screens

Menu item	Submenu	Digital input screen	Designation
<dAtA> (Data)		<d.1>	Running hours.
		<d.2>	Motor starts.
		<d.3>	Module hours.
		<d.4>	Loading hours.
		<d.5>	Load solenoid valve. Only for 5.5 - 7.5 kW (7.5 - 10 HP) units.
		<d.6>	Service timer.
<ProG> (Programming)	<rEG.P> (Regulation Pressure)	<Pr.SL>	Calling up or modifying pressure band selection.
		<LPr.1>	Calling up or modifying lower pressure setting.
		<uPr.1>	Calling up or modifying upper pressure setting.
		<LPr.2>	Calling up or modifying lower pressure setting.
		<uPr.2>	Calling up or modifying upper pressure setting.
	<tiMr> Timer	<SrV.d>	Maintenance warning.
	<diSP> (Display)	<tEMP>	Calling up or modifying unit of temperature.
		<PrES>	Calling up or modifying unit of pressure.
		<bC.LG>	Calling up or modifying time of backlight.
	<Ctrl> (Control)	<Lo.rE>	Local/remote start/stop.
		<Ar.Af>	Automatic restart after voltage failure.
		<Ar.d>	Delay time of automatic restart after voltage failure.
		<nHCA>	Maximum number of compressor starts per hour. Only for 5.5 - 7.5 kW (7.5 - 10 HP) units.
	<PASS>		Activating password protection.
	<tESt> (Test)		<tSt.1>
<InFo> (Info)		<P.rEL>	Parameter map release.
		<F.rRI>	Firmware release.
		<F.dAY>	Firmware release day.
		<F.Mnt>	Firmware release month.
		<F.YAr>	Firmware release year.
		<SEr.n>	Serial number.

3.10 Calling up running hours

Starting from the Main screen:

- Press Enter button (7) for 3 seconds to enter the Main menu.
- Select <dAtA> and press Enter button (7) to enter the Data menu.
- Scroll Up or Down buttons (4-8) until <d.1> and the motor stopped symbol is shown.
- Press Enter button (7): the running hours are shown.

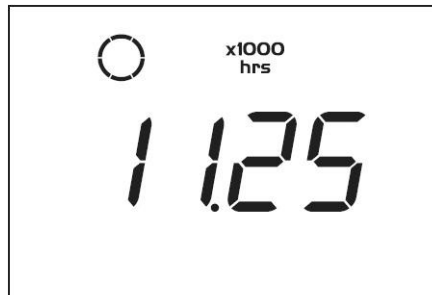

84718D

The screen shows the unit used <x1000 hrs> and the value <11.25>: the running hours of the compressor are 11250 hours.

3.11 Calling up motor starts

Starting from the Main screen:

- Press Enter button (7) for 3 seconds to enter the Main menu.
- Select <dAtA> and press Enter button (7) to enter the Data menu.
- Scroll Up or Down buttons (4-8) until <d.2> and the motor symbol is shown.
- Press Enter button (7): the number of motor starts is shown.

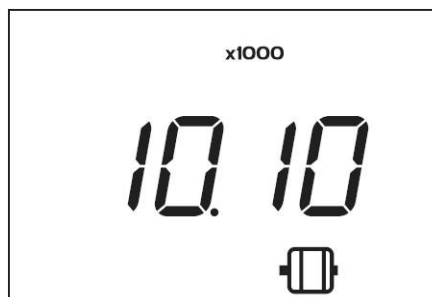

84719D

This screen shows the number of motor starts (x1 or - if <x1000> lights up - x1000). In the above example, the number of motor starts is 10100.

3.12 Calling up module hours

Starting from the Main screen:

- Press Enter button (7) for 3 seconds to enter the Main menu.
- Select <dAtA> and press Enter button (7) to enter the Data menu.
- Scroll Up or Down buttons (4-8) until <d.3> and <hrs> is shown.
- Press Enter button (7): the module time appears.



In the example shown, the screen shows the unit used <hrs> and the value <5000>: the controller module has been in service during 5000 hours.

3.13 Calling up loading hours

Starting from the Main screen:

- Press Enter button (7) for 3 seconds to enter the Main menu.
- Select <dAtA> and press Enter button (7) to enter the Data menu.
- Scroll Up or Down buttons (4-8) until <d.4> and the running loaded symbol is shown.
- Press Enter button (7): the loading time is shown.

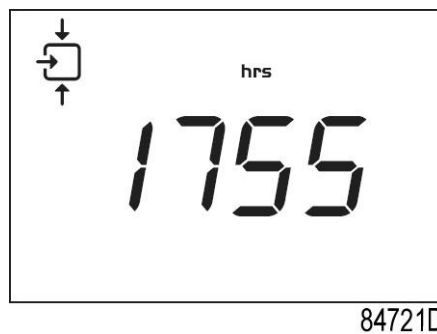

The screen shows the unit used <hrs> (or <x1000 hrs>) and the value <1755>: the compressor has been running loaded during 1755 hours.

3.14 Calling up load solenoid valve

Only for 5.5 - 7.5 kW (7.5 - 10 HP) units.

Starting from the Main screen:

- Press Enter button (7) for 3 seconds to enter the Main menu.
- Select <dAtA> and press Enter button (7) to enter the Data menu.
- Scroll Up or Down buttons (4-8) until <d.5> and the running loaded symbol is shown.
- Press Enter button (7): the number of loadings is shown.

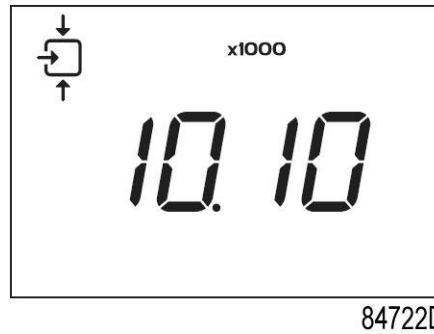

This screen shows the number of loading actions (x1 or - if <x1000> lights up - x1000). In the above example, the number of unload to load actions is 10100.

3.15 Calling up/resetting the service timer

Starting from the Main screen:

- Press Enter button (7) for 3 seconds to enter the Main menu.
- Select <dAtA> and press Enter button (7) to enter the Data menu.
- Scroll Up or Down buttons (4-8) until <d.6> and <hrs> is shown.
- Press Enter button (7): the service timer is shown.



This screen shows the unit used (<hrs> or <x1000 hrs>) and the value. In the example shown, the compressor has run 1191 hours since the previous service.

3.16 Calling up/modifying pressure band selection

Starting from the Main screen:

- Press Enter button (7) for 3 seconds to enter the Main menu.
- Select <ProG> and press Enter button (7) to enter the Programming menu.
- Scroll Up or Down buttons (4-8) to <reG.P> for regulation pressure.
- Press Enter button (7) to enter the submenu.

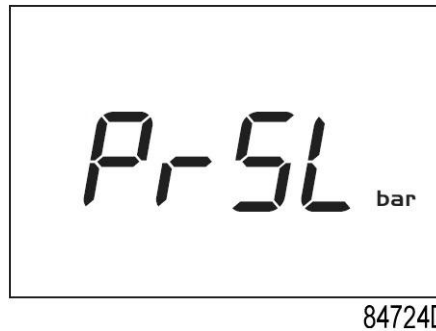

- Scroll Up or Down buttons (4-8) until <PrSL> is shown and then press Enter button (7).
- Pressure band 1 (<SEL.1>) is shown. Scroll Up or Down buttons (4–8) to pressure band 2 (<SEL.2>).
- Press Enter button (7) on the desired pressure band.

3.17 Calling up/modifying pressure band settings

Starting from the Main screen:

- Press Enter button (7) for 3 seconds to enter the Main menu.
- Select <ProG> and press Enter button (7) to enter the Programming menu.
- Scroll Up or Down buttons (4-8) to <reG.P> for regulation pressure.
- Press Enter button (7) to enter the submenu.

<LPr.1> is the parameter of Load Pressure band 1

<uPr.1> is the parameter of Unload Pressure band 1

<LPr.2> is the parameter of Load Pressure band 2

<uPr.2> is the parameter of Unload Pressure band 2

- Scroll Up or Down buttons (4-8) and press Enter button (7) to select parameter.
- The actual pressure used is shown. Scroll Up or Down buttons (4-8) to set pressure value and press Enter button (7) to confirm. The unit blinks and the new setting is saved.

3.18 Calling up/modifying the unit of temperature

The unit of temperature measurement can only be changed when the compressor is stopped.

Starting from the Main screen:

- Press Enter button (7) for 3 seconds to enter the Main menu.
- Select <ProG> and press Enter button (7) to enter the Programming menu.
- Scroll Up or Down buttons (4-8) to <diSp> for display settings.
- Press Enter button (7) to enter the submenu.
- Scroll Up or Down buttons (4-8) to <tEMP> and press Enter button (7).
- The actual unit used is shown. Possible settings are <°C > and <°F >.
- Scroll Up or Down buttons (4-8) to set the unit of temperature and press Enter button (7) to confirm. The unit blinks and is saved.

3.19 Calling up/modifying the unit of pressure

The unit of pressure measurement can only be changed when the compressor is stopped.

Starting from the Main screen:

- Press Enter button (7) for 3 seconds to enter the Main menu.
- Select <ProG> and press Enter button (7) to enter the Programming menu.
- Scroll Up or Down buttons (4-8) to <diSp> for display settings.
- Press Enter button (7) to enter the submenu.
- Scroll Up or Down buttons (4-8) to <PrES> and press Enter button (7).
- The actually used unit is shown. Possible settings are <bar>, <psi> and <MPa>.
- Scroll Up or Down buttons (4-8) to set the unit of pressure and press Enter button (7) to confirm. The unit blinks and is saved.

3.20 Calling up/modifying backlight time

The backlight will be activated after pressing any button and for the interval of time set in the parameter <bC.LG> (in sec).

Starting from the Main screen:

- Press Enter button (7) for 3 seconds to enter the Main menu.
- Select <ProG> and press Enter button (7) to enter the Programming menu.
- Scroll Up or Down buttons (4-8) to <diSp> for display settings.
- Press Enter button (7) to enter the submenu.
- Scroll Up or Down buttons (4-8) to <bC.LG> and press Enter button (7).
- The current backlight setting is shown. It is possible to set a value between 0s and 120s.
- Scroll Up or Down buttons (4-8) to set the time of backlight and press Enter button (7) to confirm. The unit blinks and is saved.

3.21 Activating automatic restart after voltage failure

Description

This function allows the compressor to restart automatically after voltage failure. The activation can only be done by your supplier. Please contact him for further details.

After any power failure, before restarting, the compressor will wait for a fixed time. When delay time is running, the display will show the related countdown value (in seconds) as below:

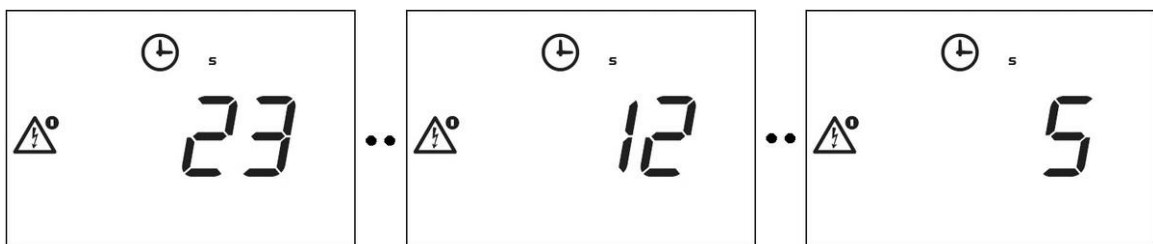

84725D

Example countdown delay time of automatic restart after power failure.

3.22 Keyboard lock

Keep both Up and Down buttons pressed for more than 3 seconds to lock or unlock the keyboard.

- The display will show the label <Loc> blinking for 3 seconds if the keyboard has been locked.
- The display will show the label <UnLo> blinking for 3 seconds if the keyboard has been unlocked.

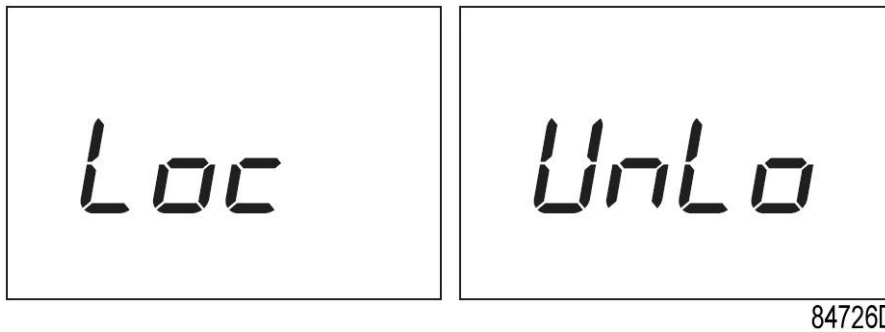

Example Lock/unlock screen.

4 Installation

4.1 Installation proposal

Outdoor/altitude operation

If the compressor is installed outdoors or if the ambient temperature can be below 0°C (32°F), precautions must be taken. In this case, and also if operating at high altitude, consult Atlas Copco.

Moving/lifting

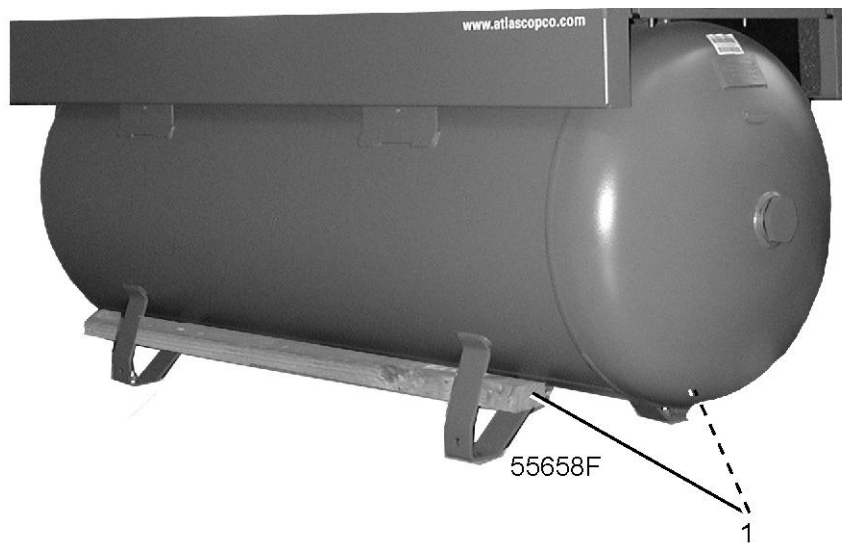

Transport by a pallet truck



To prevent a tank-mounted model from falling over during transport by a pallet truck: push the forks underneath the air receiver and place a wooden beam (1) (cross-section approx. 4 x 6 cm / 1.6 x 2.4 in) through the supports on both sides of the receiver. While holding the compressor, slowly lift the forks until the receiver is secured between the beams. Move the compressor gently.

Installation proposal

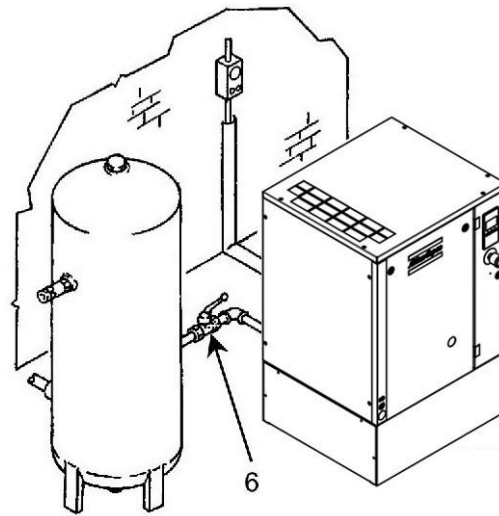

86128D

Installation proposal, floor-mounted

Ref.	Description
6	Outlet valve

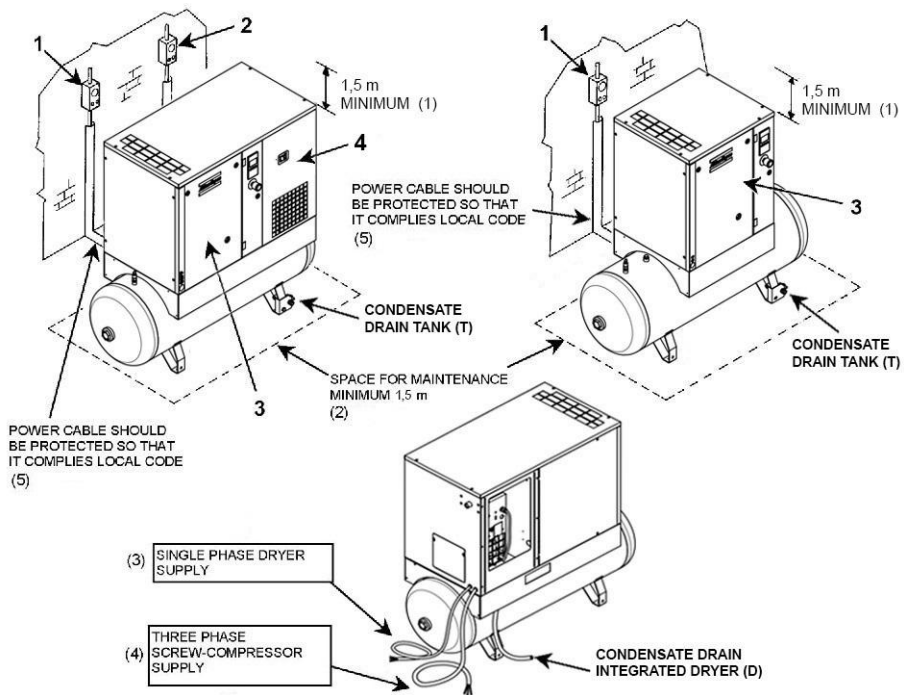

86129D

Installation proposal, tank-mounted

Ref.	Description
1	Isolating switch, compressor
2	Isolating switch, dryer

Ref.	Description
3	Front panel, compressor
4	Dryer
(1)	Minimum 1.5 m (59 in)
(2)	Space for maintenance, minimum 1.5 m (59 in)
(3)	Single-phase dryer supply
(4)	Three-phase screw compressor supply
(5)	The power cable should be protected so that it complies with local regulations

Step	Action
1	<p>Install the compressor on a solid, level floor suitable for taking the weight. The recommended minimum distance between the top of the unit and the ceiling is 1.5 m (58.5 in). The minimum distance between the wall and the back of the compressor must be 300 mm (19.5 in). Floor-mounted versions, if the compressor is not equipped with unloader valve (i.e. G2-4), must be installed with a suitable air receiver with a minimum capacity of 200 l (60 US gal). The air receiver should not be bolted to the floor.</p>
	The pipes between a floor-mounted compressor and air receiver are hot.
2	<p>Position of the compressed air outlet valve. Close the valve. Connect the air net to the valve.</p>
3	<p>The pressure drop over the air delivery pipe can be calculated as follows: $\Delta p = (L \times 450 \times Q_c^{1.85}) / (d^5 \times P)$, with d = Inner diameter of the pipe in mm Δp = Pressure drop in bar (recommended maximum: 0.1 bar (1.5 psi)) L = Length of the pipe in m P = Absolute pressure at the compressor outlet in bar Q_c = Free air delivery of the compressor in l/s</p>
4	<p>Ventilation: the inlet grids and ventilation fan should be installed in such a way that any recirculation of cooling air to the compressor or dryer is avoided. The air velocity to the grids must be limited to 5 m/s (200 in/s). The required ventilation capacity to limit the temperature of the compressor room can be calculated from the following formula: $Q_v = 0.92 N / \Delta T$ Q_v = Required ventilation capacity in m³/s N = Shaft input of compressor in kW ΔT = Temperature increase in the compressor room in °C</p>
5	Position of the mains cable entry.
6	Lay out the condensate drain pipe from the dryer automatic drain (D) as well as the pipe from the manual drain valve underneath the tank (T) towards a drain collector. The drain pipes to the drain collector must not dip into the water of the drain collector. See section Starting for the location of the components.

4.2 Dimension drawings

The dimension drawing can be found in the technical documentation supplied with the unit.

Dimension drawing	Model
9828 0842 33	G 2, G 3, G 4, G 5, G 7 Pack, floor-mounted
9828 0842 34	G 2, G 3, G 4, G 5, G 7 Full-Feature, floor-mounted
9828 0842 35	G 2, G 3, G 4, G 5, G 7 Pack, tank-mounted
9828 0842 36	G 2, G 3, G 4, G 5, G 7 Full-Feature, tank-mounted

Text on drawings	Translation or explanation
Emergency stop switch	Emergency stop switch button (only compressor)
Main power supply	Compressor power supply (supply cable)
Cooling air and compressor inlet	Cooling air and compressor inlet
Cooling air outlet of compressor and motor	Cooling air outlet of compressor and motor
Air inlet filter	Air inlet filter (only floor-mounted)
Service panel	Compressor service panel
External box	External box on back panel (depends on model)
Extra venting	Extra openings for venting on back panel (depends on model)
Compressor controller	Compressor controller (Base controller)
Oil level indicator	Oil level indicator
Compressed air outlet	Compressed air outlet
Air delivery	Compressed air outlet delivery line
Forklift openings	Forklift openings (only floor-mounted, Full-Feature)
Valve (supplied loose)	Valve air outlet (only air receiver)
Center of gravity	Center of gravity
Cubicle door fully open	Cubicle door fully open
Air receiver manual drain	Air receiver manual drain
Condensate drain dryer	Condensate drain from integrated dryer
Dryer inlet cooling air	Dryer inlet cooling air
Dryer outlet cooling air	Dryer outlet cooling air
Dryer switch	Dryer switch ON/OFF
Dryer service panel	Dryer service panel for maintenance
Dryer power supply	Dryer power supply (supply cable)

4.3 Electrical connections

	Always disconnect the power supply before working on the electrical circuit!
---	--

General instructions

Step	Action
1	Install an isolating (disconnecter) switch near the compressor.
2	Check the fuses and the setting of overload relay. See Settings for overload relay and fuses .
3	If fitted, check transformers for correct connection.
4	See Electric cable size for selection of power supply line cable. Connect the power supply cables to terminals L1, L2 and L3 (terminal block 1X0) and the neutral conductor (if applicable) to terminal (N). Connect the earth conductor to terminal PE/GND.

Specific voltage change instructions for G 2 – G 7 with 208 V / 230 V / 460 V cubicle

The standard voltage configuration for the compressor is mentioned on the data plate of the machine.

When the compressors leave the factory, the units are connected for 230 V / 3 phase.



To modify the wiring for an operating voltage of 208 V or 460 V, the main cubicle should be rewired as described below:

Modifications to the compressor cubicle:

Step	Action
1	Adjust the motor overload (F21) setting.
2	Control transformer (T1) – Move the primary connection from 230V to the desired voltage.
3	Replace the control fuses (F1) 10.3 x 38mm with the ones provided (see further). Use 0.75A fuses for 460V or 1.5A for 208V.
4	Modify the motor terminal bridge configuration in the cubicle (1X1). See further for details.
5	Replace the voltage sticker by the appropriate voltage sticker provided.

Motor overload relay (F21) setting:

Rotate the adjustment screw (1) on the front of the relay to the required value.

208V SETTING	230V SETTING	460V SETTING
Motor M1 overload adj. Moteur M1 protect. regl. F21 13.0A (3HP)	Motor M1 overload adj. Moteur M1 protect. regl. F21 12.0A (3HP)	Motor M1 overload adj. Moteur M1 protect. regl. F21 6.0A (3HP)
 20.5A (5.5HP)	 18.0A (5.5HP)	 9.0A (5.5HP)
28.0A (7.5HP)	25.5A (7.5HP)	13.0A (7.5HP)
39.0A (10HP)	35.5A (10HP)	17.5A (10HP)
		2204231931

86130D

Control transformer (T1):

Move the wire to the terminal marked with the desired voltage (208 V, 230 V or 460 V).

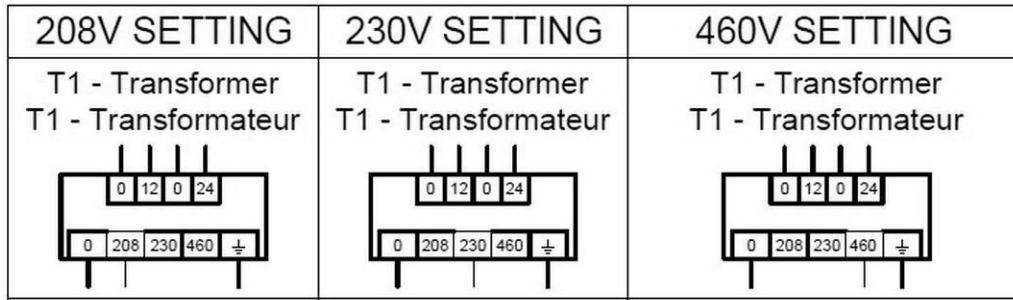

86131D

Fuses F1:

The fuses are supplied with the compressor.

208V SETTING	230V SETTING	460V SETTING
F1 - fuses KTK 1.5 F1 - fusibles KTK 1.5	F1 - fuses KTK 1.5 F1 - fusibles KTK 1.5	F1 - fuses KTK 0.75 F1 - fusibles KTK 0.75

86132D

Motor terminal bridge configuration:

Factory standard connection is 230 V and can be changed to 208 V or 460 V.

Terminal bridges (1) can be removed using a pair of pliers.

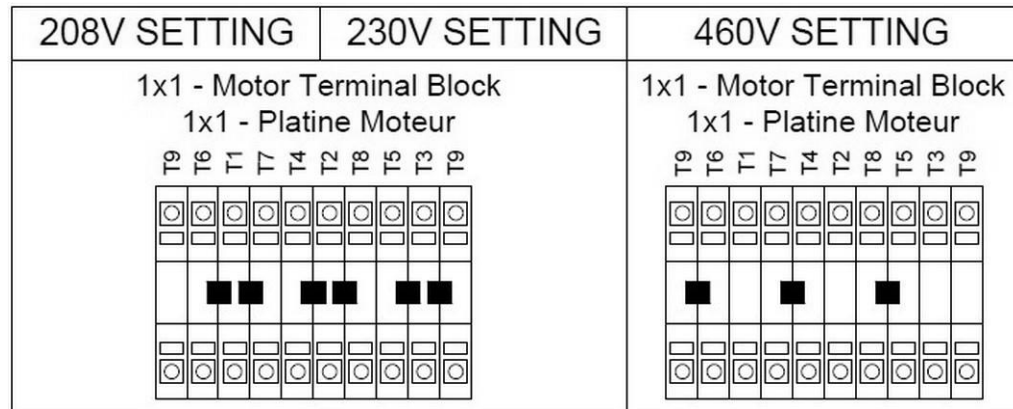

86133D

Voltage stickers:

Locate the yellow voltage labels provided with the compressor.

Replace the existing label with the appropriate voltage label (208 V, 230 V or 460 V).

4.4 Pictographs

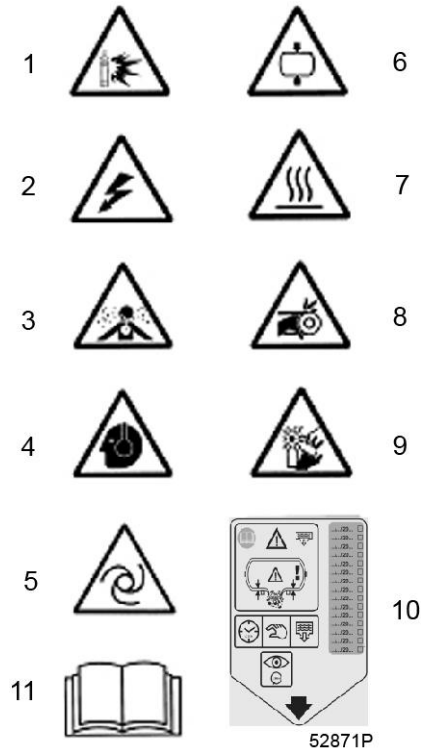

Ref.	Description
1	Warning: possible air/fluid discharge
2	Warning: voltage
3	Warning: air must not be inhaled
4	Warning: wear ear protectors
5	Warning: machine may start automatically
6	Warning: pressure
7	Warning: hot parts
8	Warning: moving parts
9	Warning: rotating fan
10	Drain the condensate daily and inspect the vessel yearly. Note down the inspection dates.
11	Read the instruction manual

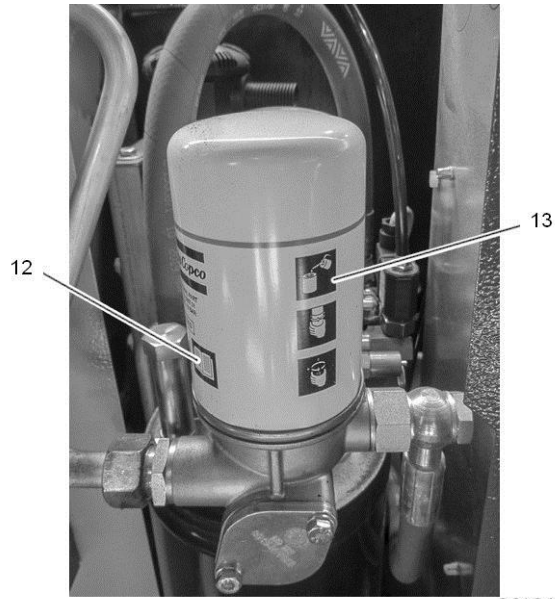

86134D

Ref.	Description
12	Read the instruction manual before carrying out any maintenance or repair work
13	Lightly oil gasket of oil filter, screw filter on and tighten by hand

5 Operating instructions

5.1 Initial start-up

Safety



The operator must apply all relevant [Safety precautions](#).

General preparation

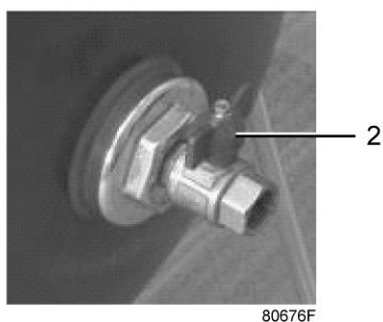

Air outlet valve on air receiver



Condensate drain valve on air receiver

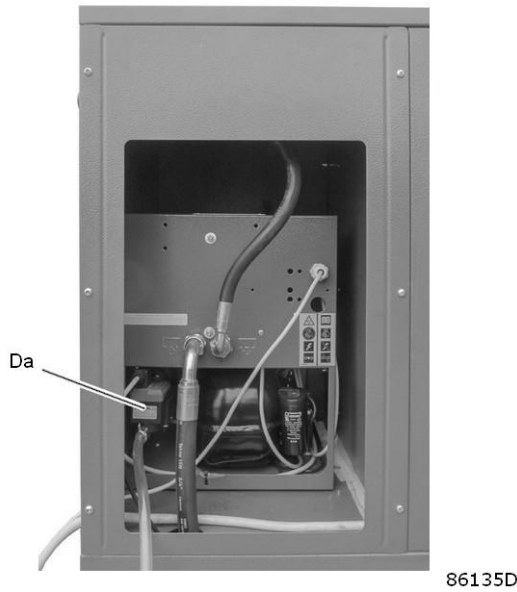

Automatic condensate drain

Step	Action
1	Consult the installation instructions (see Installation).
2	Check that the electrical connections correspond to the local codes. The installation must be earthed and protected against short circuits by fuses in all phases. An isolating switch must be installed near the compressor.
3	Fit outlet valve (2), close it and connect the air net to the valve. Connect condensate drain valve (4) of the air receiver and, if full-feature version, the automatic drain outlet (Da) to a drain collector. Close the valve.

Oil system

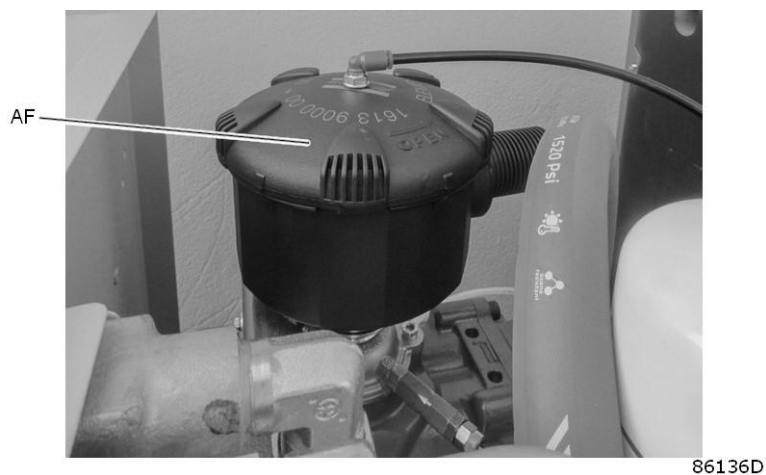

Air filter

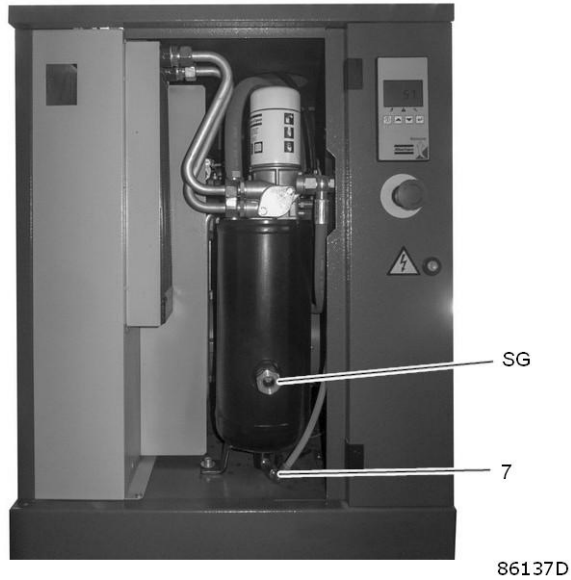

Oil level sight-glass

Step	Action
	<p>If more than 3 months have passed between assembly and installation, make sure to lubricate the compressor before starting up:</p> <ul style="list-style-type: none"> • Remove the front panel. • Unscrew the fixing bolts on the top and remove the panel. • Unscrew the cover of the air filter (AF) and remove the filter element. • Open valve (7) and drain approximately 0.2 l (0.05 US gal / 0.04 Imp gal) of oil into a clean receptacle. Carefully pour this oil through the filter housing into the compressor element. • Fit the air filter and screw on the filter cover. • Refit the top and front panels.
	<p>Check the oil level. Stop the unit and wait for the foam to disappear (normally about 3 minutes). The oil level should be visible on the sight glass (SG). Never measure the oil level on a unit that has been stopped for more than 10 minutes. Do not overfill. Always use the same type of oil.</p>

Start-up

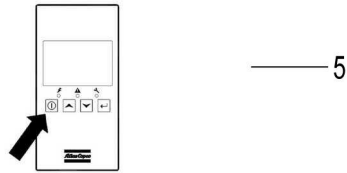

PRESS 3 SECONDS		→	WAIT FOR 1 SECOND	→	PRESS	
PREMERE 3 SECONDI		→	ASPETTARE 1 SECONDO	→	PREMERE	
APPUYER 3 SECONDES		→	ATTENDRE 1 SECONDE	→	APPUYER	
KNOPF DRÜCKEN (3 SEK)		→	EINE SEKUNDEN WARTEN	→	DRÜCKEN	
PRESSIONAR 3 SEG		→	ESPERE 1 SEGUNDO	→	PULSE	

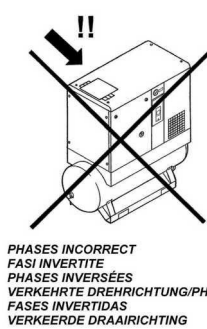
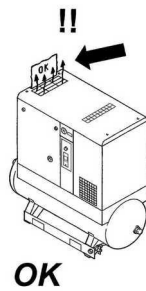

2204 1073 00

84793D

Start-up sheet

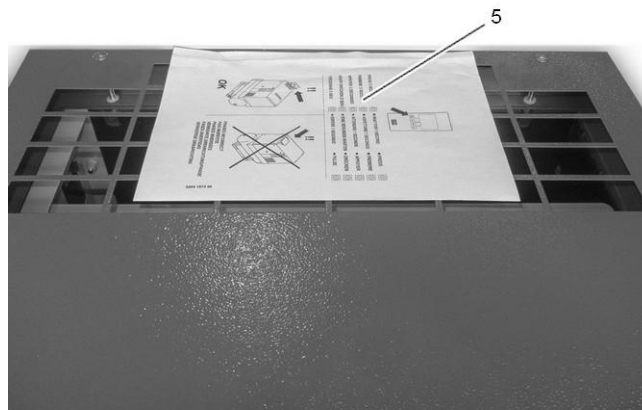

86138D

Label on the top

Step	Action
1	<p>Check that all bodywork panels are fitted.</p> <p>Check that sheet (5) (explaining the procedure for checking the motor rotation direction) is affixed to the cooling air outlet of the compressor (grating on the compressor top).</p> <p>Consult Dimension drawings.</p> <p>Switch on the voltage. Press the start button for at least 3 seconds and stop it immediately by using the emergency button.</p> <p>Check the rotation direction of the motor. If the motor rotation direction is correct, the sheet on the top grating will be blown upwards. If the sheet remains in place, the rotation direction is incorrect.</p> <p>If the rotation direction is incorrect, switch off the voltage, open the isolating (disconnecter) switch (IG) and reverse two phases of the supply cable. Switch on the voltage and restart the compressor.</p> <p>All electrical work should be carried out by professionally qualified people.</p>
2	<p>Start and run the compressor for a few minutes. Check that the compressor is operating normally.</p>

5.2 Starting

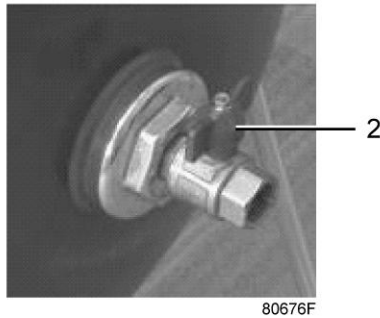

Air outlet valve on air receiver

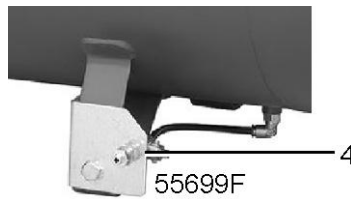

Condensate drain valve on air receiver

Starting the air dryer



52885F

Dryer on/off switch

	Switch on the voltage to the dryer and start it by moving switch (3) to position I.
	<ul style="list-style-type: none"> • Switch on the dryer before starting the compressor. • The dryer must remain switched on when the compressor is operating to ensure that the air piping remains condensate-free. • If the dryer is switched off, wait at least 5 minutes before restarting the dryer. This allows balancing the internal pressure of the dryer.

Starting the compressor

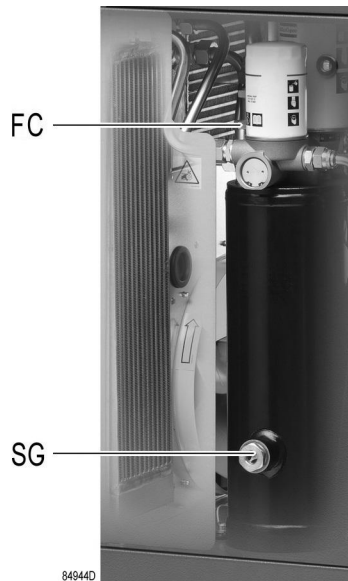

Position of oil sight glass and filler plug

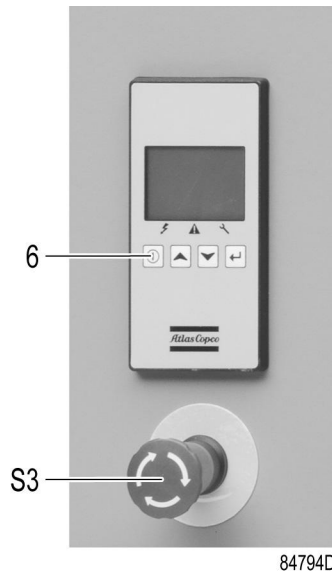

Control panel

Step	Action
1	Before starting, check the oil level in accordance with step 5 of this table.
2	Switch on the voltage.
3	Open air outlet valve (2).
4	Push the start button (6). The motor starts running after 25 seconds. On compressors with a star-delta starter, the drive motor switches over from star to delta 10 seconds after starting.
	The maximum number of motor starts must be limited to 20 per hour. It is strongly recommended to operate the compressor with a load factor of more than 10% to avoid condensate in the oil.
5	Regularly check the oil level. 10 to 15 minutes after stopping, the sight glass (SG) should be between 1/4 and 3/4 full. If the oil level is too low, stop the compressor, depressurise the oil system by unscrewing oil filler plug (FC) one turn and wait a few minutes. Remove the plug and top up the oil, until the sight glass is 3/4 full. Do not overfill. Fit and tighten plug (FC).
6	In automatic operation, the regulator is automatically controlling the compressor, i.e. loading, unloading, stopping of the motors and restarting.
7	Regularly check the working pressure and the dew point (Full-Feature units).
8	Regularly check that condensate is drained (Da) during operation.

5.3 Stopping

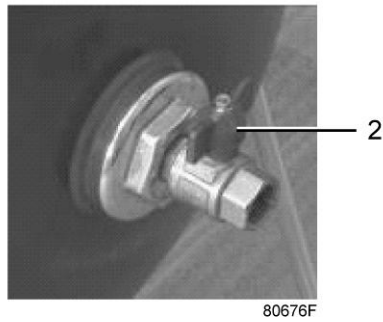

Air outlet valve

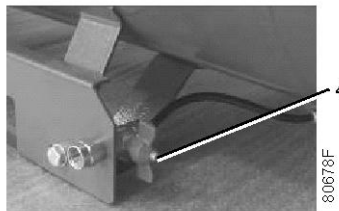

Condensate drain valve on air receiver

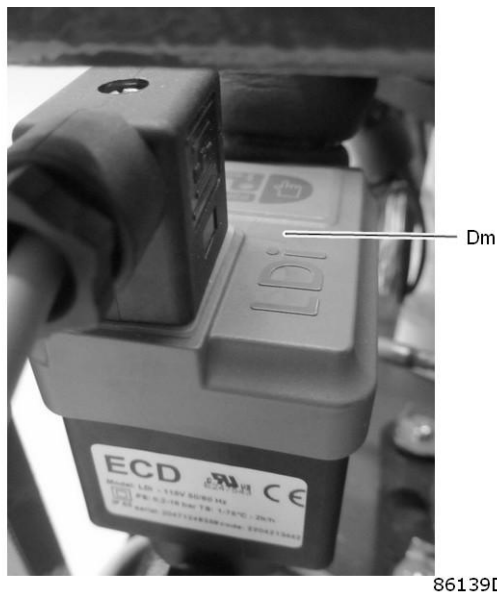

Dryer manual drain



52885F

Dryer on/off switch

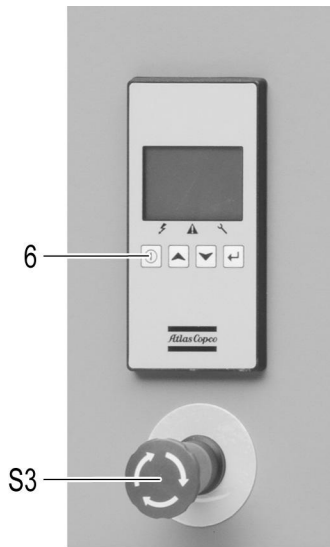

84794D

Control panel

Step	Action
1	<p>On Full-Feature units: move switch (3) of the dryer to position 0.</p> <p>Push the start/stop button (6) on the controller. The compressor will unload. When the unload time has elapsed, the compressor is stopped and the controller goes back to the main screen.</p> <p>To stop the compressor immediately in the event of an emergency, press button (S3). See section Control panel. After remedying the fault, unlock the button by pulling it out.</p>
	<p>Only use emergency stop button in the event of an emergency. Avoid using the button for normal stopping of the compressor.</p>
2	<p>Close air outlet valve (2) and switch off the voltage to the compressor.</p>
3	<p>Push condensate manual drain (Dm) for a few seconds to release any condensate from the dryer.</p> <p>Open condensate drain valve (4) of the air receiver for a few seconds to drain any condensate and then close the valve.</p>
	<p>The air dryer and the air receiver remain under pressure. The integrated filter (if installed) remains pressurised.</p> <p>If maintenance or repair work is necessary, consult the Problem solving section for all relevant safety precautions.</p>

5.4 Taking out of operation

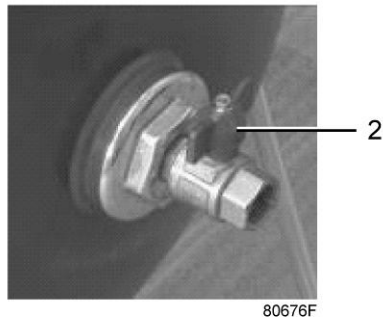

Air outlet valve

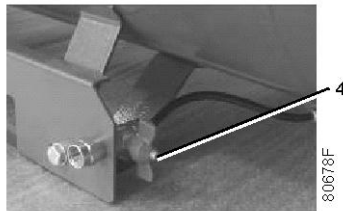

Condensate drain valve on air receiver



Oil filler plug

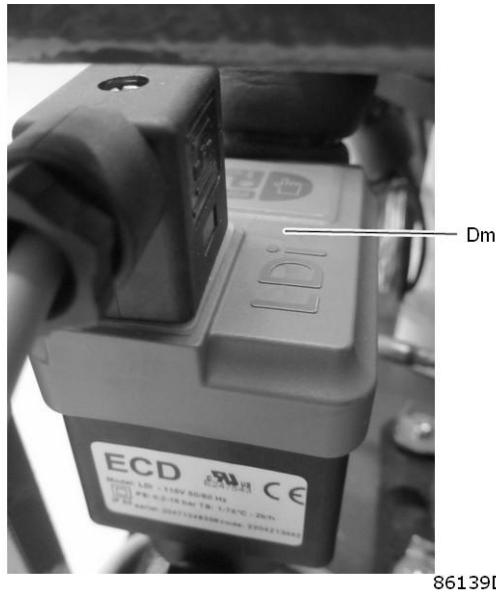

Dryer manual drain

This procedure should be carried out at the end of the compressor's service life.

Step	Action
1	On Full-Feature units: move switch (3) of the dryer to position 0. Stop the compressor and close the air outlet valve (2).
2	Switch off the voltage and disconnect the compressor from the mains.
3	Depressurize the compressor by opening plug (3) one turn. Push condensate manual drain (Dm) for a few seconds to release any condensate from the dryer. Open condensate drain valve (4) of the air receiver.
4	Shut off and depressurize the part of the air net which is connected to the outlet valve. Disconnect the compressor from the air net.
5	Drain the oil and condensate circuits.
6	Disconnect the compressor condensate outlet and valve from the condensate net.

6 Maintenance

6.1 Preventive maintenance schedule

Warning



Before carrying out any maintenance, repair work or adjustments, proceed as follows:

- Stop the compressor.
- Switch off the voltage and open the isolating switch.
- Close the air outlet valve and open the manual condensate drain valves.
- Depressurize the compressor.

For detailed instructions, see the next sections.

The operator must apply all relevant [Safety precautions](#).

Warranty-Product Liability

Use only authorized parts. Any damage or malfunction caused by the use of unauthorized parts is not covered by Warranty or Product Liability.

General

When servicing, replace all removed gaskets, O-rings and washers.

Intervals

Carry out maintenance at the interval which comes first. The local Atlas Copco Customer Center may overrule the maintenance schedule, especially the service intervals, depending on the environmental and working conditions of the compressor.

The "longer interval" checks must also include the "shorter interval" checks.

Preventive maintenance schedule for G 2 – G 7

Period (1)	Running hours (1)	Operation
Daily	--	Check the oil level. After stopping, drain the condensate from the air receiver by means of the manual drain valve (4), see section Stopping .
--	50	Check belt tension. Adjust if necessary.
Weekly	50	Drain condensate from the oil separator vessel.
3-monthly	--	For compressors with PDX filter: check the service indicator; replace the filter if necessary.
"	500 (2)	Inspect the air filter. Clean if necessary.
"	1000	Check the tension and the condition of the belts. Adjust if necessary.
"	1000 (2)	Inspect the oil cooler; clean if necessary.
"	"	For Full-Feature versions: inspect the condenser of the dryer; clean if necessary.
Yearly	4000	Replace the oil filter.

Period (1)	Running hours (1)	Operation
"	4000 (3)	If Roto-Inject Fluid Ndurance is used, change the oil.
"	4000 (2)	Replace the air filter.
"	4000 (2)	Replace the oil separator.
"	4000	Check and, if needed, replace the belts.
"	--	Have the safety valve tested.
"	"	Have the operation of sensors, electrical interlockings and components checked.
"	"	Have the temperature shut-down switch tested.
"	--	Inspect the air receiver. The air receiver must no longer be used and must be replaced if the wall thickness is less than the minimum value, specified in the technical documentation of the air receiver.
"	8000 (3)	If Roto Synthetic Fluid Xtend Duty is used, change the oil.
2-yearly	8000	Service the instrument block: Thermostatic and MPV kit.
"	8000	Check and clean the inlet valve. Use the unloader kit.
"	8000	Replace the belts.

(1): whichever comes first

(2): more frequently in a dusty environment

(3): The indicated oil exchange intervals are valid for standard operating conditions (see section [Reference conditions and limitations](#)) and nominal operating pressure (see section [Compressor data](#)). Exposure of the compressor to external pollutants or operation at high humidity combined with low duty cycles may require a shorter oil exchange interval. Contact Atlas Copco if in doubt.

Important

	<ul style="list-style-type: none"> • Always consult Atlas Copco if a service timer setting has to be changed. • For the change interval of oil and oil filter in extreme conditions, consult your Atlas Copco Customer Center. • Any leakage should be attended to immediately. Damaged hoses or flexible joints must be replaced.
---	---

6.2 Drive motor

General

Keep the outside of the electric motor clean for efficient cooling. If necessary, remove dust with a brush and/or compressed air jet.

Description

The motor bearings are greased for life.

6.3 Oil specifications

	Avoid mixing lubricants of different brands or types as they may not be compatible and the oil mix may have inferior properties. A label, indicating the type of oil filled ex factory, is stuck on the air receiver/oil tank.
---	--

It is strongly advised to use the recommended lubricants. See section Preventive maintenance schedule for recommended oil change intervals.

For part numbers, consult the Spare Parts List.

Roto-Inject Fluid NDURANCE

Exchange interval for Roto-Inject Fluid Ndurance

Ambient temperature	Element outlet temperature	Exchange interval *	Maximum time interval *
up to 30°C (86°F)	up to 95°C (203°F)	4000	1 year
from 30°C (86°F) up to 35°C (95°F) (see note)	from 95°C (203°F) up to 100°C (212°F)	3000	1 year
from 35°C (95°F) up to 40°C (104°F) (see note)	from 100°C (212°F) up to 105°C (221°F)	2000	1 year
above 40°C (104°F)	above 105°C (221°F)	use Roto Synthetic Fluid XTEND DUTY	

Note: The presence of dust and/or high humidity may require a shorter exchange interval. Consult Atlas Copco.

Atlas Copco's Roto-Inject Fluid Ndurance is a premium mineral oil based 4000 hours lubricant, specially developed for use in single stage oil-injected screw compressors running in mild conditions. Its specific formulation keeps the compressor in excellent condition. Roto-Inject Fluid Ndurance can be used for compressors operating at ambient temperatures between 0 °C (32 °F) and 40 °C (104 °F). If the compressor is regularly operating in ambient temperatures between 40 °C and 46 °C (115 °F), it is recommended to use Roto Synthetic Fluid ULTRA or Roto Synthetic Fluid XTEND DUTY.

Roto Synthetic Fluid ULTRA

Exchange interval for Roto Synthetic Fluid Ultra

Ambient temperature	Element outlet temperature	Exchange interval *	Maximum time interval *
up to 35°C (95°F)	up to 100°C (212°F)	6000	2 years
from 35°C (95°F) up to 40°C (104°F) (see note)	from 100°C (212°F) up to 105°C (221°F)	4000	2 years
from 40°C (104°F) up to 45°C (113°F) (see note)	from 105°C (221°F) up to 110°C (230°F)	2000	2 years

Note: The presence of dust and/or high humidity may require a shorter exchange interval. Consult Atlas Copco.

Roto Synthetic Fluid ULTRA is a synthetic oil based 4000 hours lubricant, specially developed for use in single stage oil-injected screw compressors running in demanding conditions. Roto Synthetic Fluid ULTRA can be used for compressors operating at ambient temperatures between 0 °C (32 °F) and 45 °C (113 °F). For more extreme conditions or when longer oil life is required, it is recommended to use Roto Synthetic Fluid XTEND DUTY.

Roto Synthetic Fluid XTEND DUTY

Exchange interval for Roto Synthetic Xtend Duty

Ambient temperature	Element outlet temperature	Exchange interval *	Maximum time interval *
up to 35°C (95°F)	up to 100°C (212°F)	8000	2 years
from 35°C (95°F) up to 40°C (104°F) (see note)	from 100°C (212°F) up to 105°C (221°F)	6000	2 years
above 40°C (104°F)	above 105°C (221°F)	5000	2 years

Note: The presence of dust and/or high humidity may require a shorter exchange interval. Consult Atlas Copco.

Atlas Copco's Roto Synthetic Fluid XTEND DUTY is a high quality synthetic 8000 hours lubricant for oil injected screw compressors which keeps the compressor in excellent condition. Because of its excellent oxidation stability, Roto Synthetic Fluid XTEND DUTY can be used for compressors operating at ambient temperatures between 0 °C (32 °F) and 46 °C (115 °F). Roto Synthetic Fluid XTEND DUTY is the standard lubricant for oil injected screw compressors equipped with freeze protection or Energy Recovery.

6.4 Oil, filter and separator change

Important



Never mix oils of different brands or types. A label, indicating the type of oil filled ex-factory, is attached on the air receiver/oil tank.
 Always drain the compressor oil at all drain points. Used oil left in the compressor can shorten the lifetime of the new oil.
 If the compressor is exposed to external pollutants, used at high temperatures (oil temperature above 90°C / 194°F) or used under severe conditions, it is advised to change the oil more frequently. Consult your supplier.

Procedure

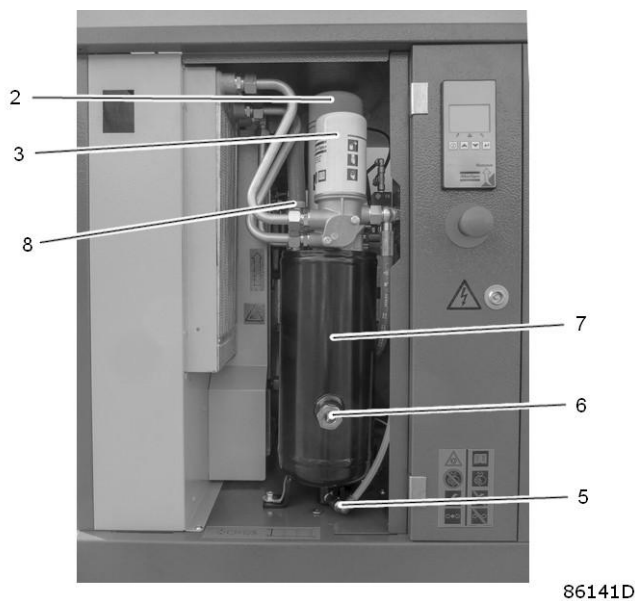

Location of oil filter and separator



Drain valve of air receiver

Step	Action
1	Run the compressor until warm. Stop the compressor, close the air outlet valve and switch off the voltage. (See section Stopping)
2	Remove the front and top panels.
3	Depressurize the compressor by unscrewing filler plug (8) one turn to permit any pressure in the system to escape. Remove the plug after the system is depressurized.
4	Depressurize the air receiver by opening drain valve (4).
5	Drain the oil by opening drain valve (5). Close the valve after draining. Deliver the drained oil to the local oil collection service.
6	Remove oil filter (3) and separator (2). Clean the seats on the manifold.
7	Oil the gaskets of the new filter and separator and screw them into place. Tighten firmly by hand.
8	Remove filler plug (8) and fill oil tank (7) with oil until the level reaches the top of sight-glass (6). Ensure no dirt gets into the system. Refit and tighten filler plug (8).
9	Fit the bodywork panels.
10	Close drain valve (4) of the air receiver.
11	Run the compressor for a few minutes.

Step	Action
12	Stop the compressor and wait a few minutes to allow the oil to settle and the foam disappears.
13	If the oil level is too low, depressurize the system by unscrewing filler plug (8) one turn to permit any pressure in the system to escape. Depressurize the air receiver by opening drain valve (4).
14	Add oil as necessary. The sight-glass should be 3/4 full. Retighten plug (8) and close drain valve (4) of the air receiver.

6.5 Storage after installation

If the compressor is stored without running from time to time, consult Atlas Copco as protective measures may be necessary.

6.6 Service kits

Service kits

For overhauling and for preventive maintenance, a wide range of service kits is available. Service kits comprise all parts required for servicing the component and offer the benefits of genuine Atlas Copco parts while keeping the maintenance budget low.

Also a full range of extensively tested lubricants, suitable for your specific needs is available to keep the compressor in excellent condition.

Consult the Spare Parts List for part numbers.

7 Adjustments and servicing procedures

7.1 Air filter

Changing the air filter

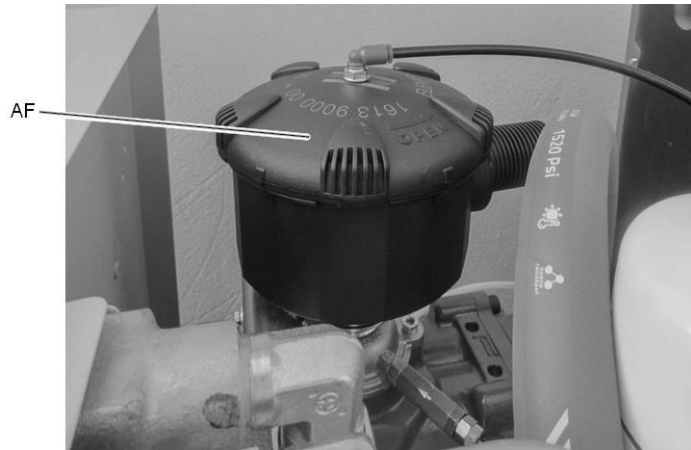

86136D

Air filter

Procedure:

Step	Action
1	Stop the compressor, close the air outlet valve and switch off the voltage.
2	Remove the front panel and the top panel of the compressor housing.
3	Unscrew the filter cover (AF) and remove the filter element. Discard the air filter element.
4	Fit the new element and screw on the filter cover.
5	Refit the top and front panels.

7.2 Coolers

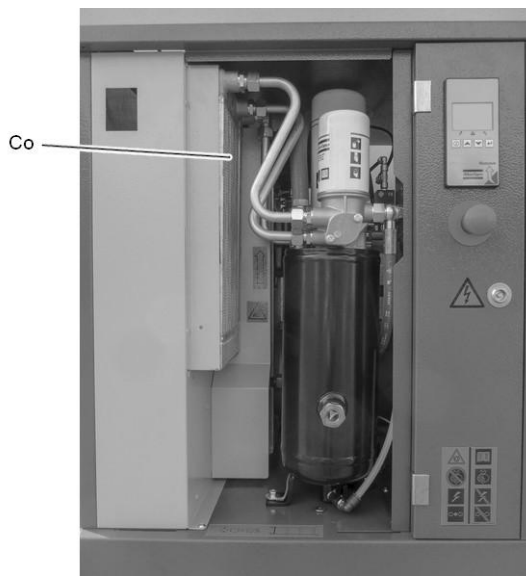

86142D

Oil cooler

Step	Action
1	Keep the oil cooler (Co) clean to maintain the cooling efficiency.
2	Stop the compressor, close the air outlet valve and switch off the voltage. Remove any dirt from the cooler with a fibre brush. Then clean using an air jet. Never use a wire brush or metal objects.

7.3 Safety valve



Condensate drain valve on air receiver



86140D

Oil filler plug

Testing

The valve can be tested on a separate compressed air line.

Before removing the valve, stop the compressor (see section [Stopping](#)).

On a Full-Feature unit also stop the dryer.

Close the air outlet valve, switch off the voltage, open drain valves (4) (if applicable) and unscrew filler plug (3) one turn to permit any pressure in the system to escape.



If the valve does not open at the set pressure stamped on the valve, replace the valve. No adjustments are allowed. Never run the compressor without a safety valve.

7.4 Belt set exchange and tensioning

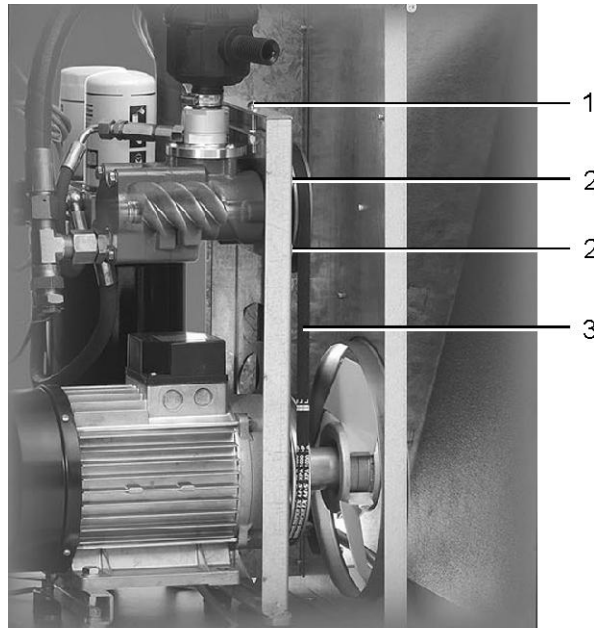

52880F

	Read the warning in the Preventive maintenance schedule section.
--	--

Belt tensioning procedure

Step	Action
1	Stop the compressor, close the air outlet valve and switch off the voltage. For Full-Feature versions: also stop the dryer. (See section Stopping)
2	Remove the front panel of the compressor housing.
3	Remove the side, back and top panels of the compressor housing.
4	Loosen the 4 bolts (2) by one turn.
5	Adjust the belt tension by turning tensioning nut (1).
6	The tension is correct when a force of 50 N (11.25 lbf) applied at the midpoint of the belt causes a deflection of 6 mm (0.23 in).
7	Retighten bolts (2).
8	Refit the bodywork panels.

Belt replacement procedure

Step	Action
1	Stop the compressor, close the air outlet valve and switch off the voltage. For Full-Feature versions: also stop the dryer.
2	Remove the front panel of the compressor housing.
3	Remove the side, back and top panels of the compressor housing.
4	Loosen the 4 bolts (2) by one turn.

Step	Action
5	Release the belt tension by loosening tensioning nut (1).
6	Remove the fan cowl.
7	Remove the belt via the fan cowl opening. Install the new belt via the same opening.
8	Tension belt (3) as described above.
9	Re-assemble the fan cowl.
10	Refit the bodywork panels.
11	Check the belt tension after 50 running hours.



Tensioning of the belts must be performed with specific dedicated tooling.

8 Problem solving

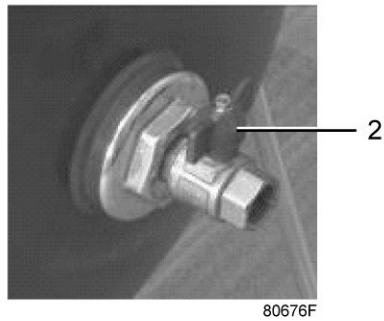

Air outlet valve

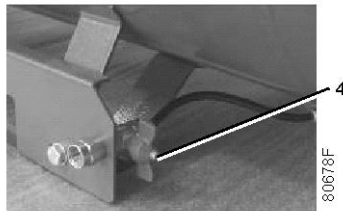

Condensate drain valve on air receiver

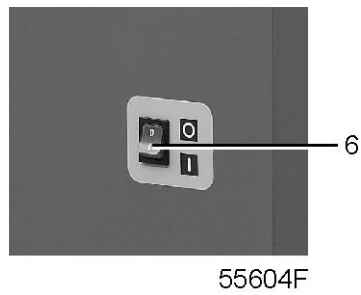

Dryer on/off switch

Attention

	<p>Use only authorized parts. Any damage or malfunction caused by the use of unauthorized parts is not covered by Warranty or Product Liability. Apply all relevant Safety precautions during maintenance or repair.</p>
	<p>Before carrying out any maintenance or repair work on the compressor: push the stop button (6). Wait until the compressor has stopped and switch off the voltage. See the Stopping section. Open the isolating switch to prevent an accidental start. Close air outlet valve (2) and depressurize the compressor by opening the oil filler plug (3) one turn. Open manual condensate drain valves (4 and/or 5).</p>
	<p>The air outlet valve (2) can be locked during maintenance or repair as follows:</p> <ul style="list-style-type: none"> • Close the valve. • Remove the screw fixing the handle. • Remove the handle. • Fit the screw.

Faults and remedies

For all references given hereafter, see [Air flow diagram](#), [Initial start-up](#) or [Regulating system](#).

Compressor

	Condition	Fault	Remedy
1	The machine does not start	No power	Check power supply
		Fuse (F1) blown	Replace fuse
		The main motor thermal protection has tripped	Check and let motor cool down; to reset/restart, move compressor start/stop switch to 0, then to I
2	The machine does not start, high oil temperature lamp is on (temperature switch tripped)	Oil cooler is dirty	Clean cooler
		Ambient temperature too high	Improve ventilation in compressor room
		Oil level too low	Top up oil tank
3	The compressor does not reach working pressure	Blow-off solenoid valve (Y1) remains open	Check; replace valve if necessary
4	Excess oil consumption	Oil separator (OS) clogged	Replace oil separator
		Oil level too high	Drain to correct level

Air dryer

	Condition	Fault	Remedy
1	No compressed air passes through the dryer	Pipes are frozen inside	Hot-gas by-pass valve malfunctioning; consult Atlas Copco
2	Condensate in the piping	Insufficient condensate drain	Check the operation of timer (T)
		The dryer is working outside its rating	Check room temperature - air temperature at dryer. Clean the condenser and check operation of fan

	Condition	Fault	Remedy
3	The compressor head is very hot (above 55°C / 131°F) - motor overload	The dryer is working outside its rating	Check room temperature - air temperature at dryer. Clean the condenser and check operation of fan
		Insufficient refrigerant in dryer	Have system checked for leaks or refilled
4	The motor hums and does not start	Line voltage too low	Check power supply
		The machine was switched off and on again too rapidly (not enough time for the pressure equalization)	Wait a few minutes before starting the machine again

9 Technical data

9.1 Electric cable size

Attention



Local regulations remain applicable if they are stricter than the values proposed below. The voltage drop must not exceed 5 % of the nominal voltage. It may be necessary to use cables of a larger size than those stated to comply with this requirement.

Recommended cable size

Cable size, IEC

Voltage (V)	Frequency (Hz)	Cable size				
		G 2	G 3	G 4	G 5	G 7
230/1	50	4 mm ²	-	-	-	-
230/3	50	1.5 mm ²	2.5 mm ²	4 mm ²	4 mm ²	6 mm ²
380/3	60	0.75 mm ²	-	1.5 mm ²	2.5 mm ²	4 mm ²
400/3	50	0.75 mm ²	1 mm ²	1.5 mm ²	2.5 mm ²	4 mm ²

Cable size, UL/CSA

Voltage (V)	Frequency (Hz)	Cable size			
		G 2	G 4	G 5	G 7
230/1	60	AWG10	AWG8	AWG8	-
208/3	60	AWG12	AWG10	AWG8	AWG8
230/3	60	AWG14	AWG10	AWG10	AWG8
460/3	60	AWG14	AWG14	AWG14	AWG12
575/3	60	AWG14	AWG14	AWG14	AWG14

9.2 Settings for overload relay and fuses

Fuse size, IEC

Voltage (V)	Frequency (Hz)	Fuse size, Gg type				
		IEC	G 2	G 3	G 4	G 5
230/1	50	25A	-	-	-	-
230/3	50	16A	20A	25A	32A	40A
380/3	60	10A	-	16A	20A	25A
400/3	50	10A	12A	16A	20A	25A

Fuse size, UL/CSA

Voltage (V)	Frequency (Hz)	Fuse size, J or RK5 type			
		UL/CSA	G 2	G 4	G 5
230/1	60	25A	40A	45A	-
208/3	60	15A	25A	30A	45A
230/3	60	12A	25A	30A	45A
460/3	60	7A	12A	15A	25A
575/3	60	6A	10A	12A	15A

F21 setting, IEC

Voltage (V)	Frequency (Hz)	F21 setting					
		IEC	G 2	G 3	G 4 (DOL)	G 4 (YD)	G 5
230/1	50	20.0A	-	-	-	-	-
230/3	50	12.5A	15.5A	19.0A	11.0A	15.0A	23.3A
380/3	60	7.5A	-	12.5A	7.5A	9.0A	10.5A
400/3	50	7.0A	9.0A	11.0A	6.5A	8.5A	13.5A

F21 setting, UL/CSA

Voltage (V)	Frequency (Hz)	F21 setting			
		UL/CSA	G 2	G 4	G 5
230/1	60	20.0A	33.0A	38.0A	-
208/3	60	13.0A	20.5A	28.0A	39.0A
230/3	60	12.0A	18.0A	25.5A	35.5A
460/3	60	6.0A	9.0A	13.0A	17.5A
575/3	60	4.5A	7.5A	10.0A	13.0A

9.3 Reference conditions and limitations

Reference conditions

Air inlet pressure (absolute)	bar	1
Air inlet pressure (absolute)	psi	14.5
Air inlet temperature	°C	20
Air inlet temperature	°F	68
Relative humidity	%	0
Working pressure	bar(e)	See Compressor data
Working pressure	psi	See Compressor data

Limitations

Maximum working pressure	bar(e)	See Compressor data
Maximum working pressure	psig	See Compressor data
Minimum working pressure	bar(e)	4
Minimum working pressure	psig	58
Maximum air inlet temperature	°C	46
Maximum air inlet temperature	°F	115
Minimum ambient temperature	°C	0
Minimum ambient temperature	°F	32

9.4 Compressor data



All data specified below apply under reference conditions, see section Reference conditions and limitations.

50 Hz 10 bar

Compressor type		G 2	G 3	G 4	G 5	G 7
Frequency	Hz	50	50	50	50	50
Maximum (unloading) pressure, Pack	bar(e)	10	10	10	10	10
Maximum (unloading) pressure, Pack	psig	145	145	145	145	145
Maximum (unloading) pressure, Full-Feature	bar(e)	9.75	9.75	9.75	9.75	9.75
Maximum (unloading) pressure, Full-Feature	psig	141	141	141	141	141
Nominal working pressure	bar(e)	9.5	9.5	9.5	9.5	9.5
Nominal working pressure	psig	138	138	138	138	138
Pressure drop over dryer	bar(e)	0.15	0.15	0.15	0.25	0.25
Pressure drop over dryer	psig	2.18	2.18	2.18	3.62	3.62
Motor shaft speed	rpm	2860	2880	2870	2870	2940

Compressor type		G 2	G 3	G 4	G 5	G 7
Set-point, thermostatic valve	°C	71	71	71	71	71
Set-point, thermostatic valve	°F	160	160	160	160	160
Temperature of air leaving receiver (approx.), Pack	°C	33	33	33	33	33
Temperature of air leaving receiver (approx.), Pack	°F	91	91	91	91	91
Pressure dew-point, Full-Feature	°C	3	3	3	3	3
Pressure dew-point, Full-Feature	°F	37	37	37	37	37
Power input, Pack at maximum working pressure	kW	3.9	4.4	5.5	7.6	9.5
Power input, Pack at maximum working pressure	hp	5.2	5.9	7.4	10.2	12.7
Power consumption, dryer at full load	kW	0.24	0.24	0.24	0.26	0.47
Power consumption, dryer at full load	hp	0.32	0.32	0.32	0.35	0.63
Power consumption, dryer at no load	kW	0.16	0.16	0.16	0.19	0.29
Power consumption, dryer at no load	hp	0.22	0.22	0.22	0.26	0.39
Refrigerant type		R513A	R513A	R513A	R513A	R513A
Total amount, refrigerant	kg	0.17	0.17	0.17	0.29	0.35
Total amount, refrigerant	lb	0.37	0.37	0.37	0.64	0.77
Oil capacity	l	2.5	2.5	2.5	3.15	3.15
Oil capacity	US gal	0.66	0.66	0.66	0.83	0.83
Sound pressure level floor-mounted units (according to ISO 2151 (2004))	dB(A)	61	61	62	65	67

50 Hz 8 bar

Compressor type		G 2	G 3	G 4	G 5	G 7
Frequency	Hz	50	50	50	50	50
Maximum (unloading) pressure, Pack	bar(e)	8	8	8	8	8
Maximum (unloading) pressure, Pack	psig	116	116	116	116	116
Maximum (unloading) pressure, Full-Feature	bar(e)	7.75	7.75	7.75	7.75	7.75
Maximum (unloading) pressure, Full-Feature	psig	112	112	112	112	112
Nominal working pressure	bar(e)	7.5	7.5	7.5	7.5	7.5
Nominal working pressure	psig	108	108	108	108	108
Pressure drop over dryer	bar(e)	0.15	0.15	0.15	0.25	0.25
Pressure drop over dryer	psig	2.18	2.18	2.18	3.62	3.62
Motor shaft speed	rpm	2860	2880	2870	2870	2940
Set-point, thermostatic valve	°C	71	71	71	71	71
Set-point, thermostatic valve	°F	160	160	160	160	160
Temperature of air leaving receiver (approx.), Pack	°C	33	33	33	33	33
Temperature of air leaving receiver (approx.), Pack	°F	91	91	91	91	91
Pressure dew-point, Full-Feature	°C	3	3	3	3	3
Pressure dew-point, Full-Feature	°F	37	37	37	37	37

Compressor type		G 2	G 3	G 4	G 5	G 7
Power input, Pack at maximum working pressure	kW	3.9	4.4	5.5	7.6	9.5
Power input, Pack at maximum working pressure	hp	5.2	5.9	7.4	10.2	12.7
Power consumption, dryer at full load	kW	0.24	0.24	0.24	0.26	0.47
Power consumption, dryer at full load	hp	0.32	0.32	0.32	0.35	0.63
Power consumption, dryer at no load	kW	0.16	0.16	0.16	0.19	0.29
Power consumption, dryer at no load	hp	0.22	0.22	0.22	0.26	0.39
Refrigerant type		R513A	R513A	R513A	R513A	R513A
Total amount, refrigerant	kg	0.17	0.17	0.17	0.29	0.35
Total amount, refrigerant	lb	0.37	0.37	0.37	0.64	0.77
Oil capacity	l	2.5	2.5	2.5	3.15	3.15
Oil capacity	US gal	0.66	0.66	0.66	0.83	0.83
Sound pressure level floor-mounted units (according to ISO 2151 (2004))	dB(A)	61	61	62	65	67

60 Hz 10 bar (145 psi)

Compressor type		G 2	G 4	G 5	G 7
Frequency	Hz	60	60	60	60
Maximum (unloading) pressure, Pack	bar(e)	10	10	10	10
Maximum (unloading) pressure, Pack	psig	145	145	145	145
Maximum (unloading) pressure, Full-Feature	bar(e)	9.75	9.75	9.75	9.75
Maximum (unloading) pressure, Full-Feature	psig	141	141	141	141
Nominal working pressure	bar(e)	9.5	9.5	9.5	9.5
Nominal working pressure	psig	138	138	138	138
Pressure drop over dryer	bar(e)	0.15	0.15	0.25	0.25
Pressure drop over dryer	psig	2.18	2.18	3.62	3.62
Motor shaft speed	rpm	3550	3480	3520	3540
Set-point, thermostatic valve	°C	71	71	71	71
Set-point, thermostatic valve	°F	160	160	160	160
Temperature of air leaving receiver (approx.), Pack	°C	33	33	33	33
Temperature of air leaving receiver (approx.), Pack	°F	91	91	91	91
Pressure dew-point, Full-Feature	°C	3	3	3	3
Pressure dew-point, Full-Feature	°F	37	37	37	37
Power input, Pack at maximum working pressure	kW	3.6	5.5	7.6	9.4
Power input, Pack at maximum working pressure	hp	4.8	7.4	10.2	12.6
Power consumption, dryer at full load	kW	0.24	0.24	0.26	0.47
Power consumption, dryer at full load	hp	0.32	0.32	0.35	0.63
Power consumption, dryer at no load	kW	0.16	0.16	0.19	0.29
Power consumption, dryer at no load	hp	0.22	0.22	0.26	0.39
Refrigerant type		R513A	R513A	R513A	R513A
Total amount, refrigerant	kg	See dataplate			
Total amount, refrigerant	lb	See dataplate			

Compressor type		G 2	G 4	G 5	G 7
Oil capacity	l	2.5	2.5	3.15	3.15
Oil capacity	US gal	0.66	0.66	0.83	0.83
Sound pressure level floor-mounted units (according to ISO 2151 (2004))	dB(A)	61	62	65	67

60 Hz 8 bar (116 psi)

Compressor type		G 2	G 4	G 5	G 7
Frequency	Hz	60	60	60	60
Maximum (unloading) pressure, Pack	bar(e)	8	8	8	8
Maximum (unloading) pressure, Pack	psig	116	116	116	116
Maximum (unloading) pressure, Full-Feature	bar(e)	7.75	7.75	7.75	7.75
Maximum (unloading) pressure, Full-Feature	psig	112	112	112	112
Nominal working pressure	bar(e)	7.5	7.5	7.5	7.5
Nominal working pressure	psig	108	108	108	108
Pressure drop over dryer	bar(e)	0.15	0.15	0.25	0.25
Pressure drop over dryer	psig	2.18	2.18	3.62	3.62
Motor shaft speed	rpm	3550	3480	3520	3540
Set-point, thermostatic valve	°C	71	71	71	71
Set-point, thermostatic valve	°F	160	160	160	160
Temperature of air leaving receiver (approx.), Pack	°C	33	33	33	33
Temperature of air leaving receiver (approx.), Pack	°F	91	91	91	91
Pressure dew-point, Full-Feature	°C	3	3	3	3
Pressure dew-point, Full-Feature	°F	37	37	37	37
Power input, Pack at maximum working pressure	kW	3.6	5.5	7.6	9.4
Power input, Pack at maximum working pressure	hp	4.8	7.4	10.2	12.6
Power consumption, dryer at full load	kW	0.24	0.24	0.26	0.47
Power consumption, dryer at full load	hp	0.32	0.32	0.35	0.63
Power consumption, dryer at no load	kW	0.16	0.16	0.19	0.29
Power consumption, dryer at no load	hp	0.22	0.22	0.26	0.39
Refrigerant type		R513A	R513A	R513A	R513A
Total amount, refrigerant	kg	See dataplate			
Total amount, refrigerant	lb	See dataplate			
Oil capacity	l	2.5	2.5	3.15	3.15
Oil capacity	US gal	0.66	0.66	0.83	0.83
Sound pressure level floor-mounted units (according to ISO 2151 (2004))	dB(A)	61	62	65	67

10 Instructions for use

Oil separator vessel

1	The vessel can contain pressurized air. This can be potentially dangerous if the equipment is misused.
2	This vessel must only be used as a compressed air/oil separator tank and must be operated within the limits specified on the data plate.
3	No alterations must be made to this vessel by welding, drilling or other mechanical methods without the written permission of the manufacturer.
4	The pressure and temperature of this vessel must be clearly indicated.
5	The safety valve must correspond with pressure surges of 1.1 times the maximum allowable operating pressure. It should guarantee that the pressure will not permanently exceed the maximum allowable operating pressure of the vessel.
6	Use only oil as specified by the manufacturer.
7	In case of misuse of the units (frequent operation with too low oil temperature or long interval of shut down), a certain amount of condensate can gather in the oil separator vessel which must be properly drained. To do so, disconnect the unit from the power line and wait until it cools down and is depressurized. Next drain the water by means of the oil drain valve, which is located at the bottom of the oil separator vessel. Local legislation may require periodic inspection.

Air receiver (on tank-mounted units)

1	Corrosion must be prevented: depending on the conditions of use, condensate may accumulate inside the tank and must be drained every day. This may be done manually by opening the drain valve, or by means of the automatic drain, if fitted to the tank. Nevertheless, a weekly check of correct functioning of the automatic valve is needed. This has to be done by opening the manual drain valve and checking for condensate. Verify that no rust obstructions affect the drain system.
2	Yearly service inspection of the air receiver is needed, as internal corrosion can reduce the steel wall thickness with the consequent risk of bursting. Local rules need to be respected, if applicable. The use of the air receiver is forbidden once the wall thickness reaches the minimum value as indicated in the service manual of the air receiver (part of the documentation delivered with the unit).
3	Lifetime of the air receiver mainly depends on the working environment. Installing the compressor in a dirty and corrosive environment is not allowed, as this can reduce the vessel lifetime dramatically.
4	Do not anchor the vessel or attached components directly to the ground or fixed structures.
5	Use the vessel within the pressure and temperature limits stated on the nameplate and the testing report.
6	No alterations must be made to this vessel by welding, drilling or other mechanical methods.

11 Guidelines for inspection

Guidelines

On the Declaration of Conformity / Declaration by the Manufacturer, the harmonised and/or other standards that have been used for the design are shown and/or referred to.

The Declaration of Conformity / Declaration by the Manufacturer is part of the documentation that is supplied with this compressor.

Local legal requirements and/or use outside the limits and/or conditions as specified by the manufacturer may require other inspection periods as mentioned below.

12 Pressure equipment directives

Components subject to 2014/68/EU Pressure Equipment Directive (PED)

Components subject to 2014/68/EU PED greater than or equal to category II:
safety valves.

See the spare parts book for part numbers.

Overall rating

The compressors conform to PED smaller than category I.

13 Declaration of conformity

Insert logo here

EU DECLARATION OF CONFORMITY

1
 2 We, (1) declare under our sole responsibility, that the product
 3 Machine name :
 4 Machine type :
 5 Serial number :
 6 Which falls under the provisions of article 12.2 of the EC Directive 2006/42/EC on the approximation of the laws of the Member States relating to machinery, is in conformity with the relevant Essential Health and Safety Requirements of this directive.

The machinery complies also with the requirements of the following directives and their amendments as indicated.

	Directive on the approximation of laws of the Member States relating to	Harmonized and/or Technical Standards used	Att'mnt
a	(2)	(3)	
b			X
c			
d			X
e			
f			
g			X

8.a The harmonized and the technical standards used are identified in the attachments hereafter

8.b <1> is authorized to compile the technical file.

	Conformity of the specification to the directives	Conformity of the product to the specification and by implication to the directives
11 Issued by	Engineering	Manufacturing
12		
13 Name		
14 Signature		
15 Date		
16 Place		

84950D

Typical example of a Declaration of Conformity document

(1): Contact address:
 Atlas Copco Airpower n.v.
 P.O. Box 100
 B-2610 Wilrijk (Antwerp)
 Belgium

(2): Applicable directives

(3): Standards used

On the Declaration of Conformity / Declaration by the Manufacturer, the harmonized and/or other standards that have been used for the design are shown and/or referred to.

The Declaration of Conformity / Declaration by the Manufacturer is part of the documentation that is supplied with this device.

COMMITTED TO SUSTAINABLE PRODUCTIVITY

We stand by our responsibilities towards our customers, towards the environment and the people around us. We make performance stand the test of time. This is what we call — Sustainable Productivity.

www.atlascopco.com

